

BATTERY POWERED PLASTIC STRAPPING MACHINE Q31



**Operating Manual
/ Spare Parts**

1. SAFETY INSTRUCTION	2
1.1 Personal Safety.....	2
1.2 Work Area Safety.....	3
1.3 Power Tool Use And Care.....	3
1.4 Battery Tool Use And Care.....	3
1.5 Hazards of Incorrect Operation.....	4
1.6 Straps Dispenser.....	4
1.7 Welding Effects.....	4
1.8 Correct Strap Cutting.....	5
1.9 Regular Maintenance.....	5
2. TECHNICAL PARAMETERS	6
2.1 Machine Introduction.....	6
2.2 Dimensions.....	6
2.3 Strap Specification.....	6
2.4 Strap Strength.....	6
2.5 Working Temperature.....	6
3. ATTACHMENT	7
3.1 Battery Specification.....	7
3.2 Charger Specification.....	7
3.3 One Set of Tool Kit For Free.....	7
3.4 Suspension System(optional).....	7
4. MACHINE APPEARANCE AND OPERATING PANEL	9
5. OPERATION STEPS	10
5.1 Installation.....	10
5.2 Operation Function Description.....	11
5.2.1 Operation Panel And Buttons.....	11
5.2.2 Basic Settings.....	13
5.2.3 Strapping Operation Steps.....	15
5.2.4 Operation Methods for Three Modes.....	16
5.2.5 Operation Essentials For Three Modes.....	17
5.3 Strapping Effect and Adjustment.....	18
5.3.1 Strap Welding Effect Judgment.....	18
5.3.2 Appropriate Parameter Adjustment.....	18
5.3.3 Reference for Tension Force (Unit: N).....	19
6. WIRING DIAGRAM	20
7. COMMON FAULT INDICATION AND TROUBLESHOOTING	21
7.1 Machine Fault Code Description.....	21
7.2 Common Faults and Troubleshooting.....	21
8. REPLACEMENT OF WEARING PARTS	22
9. SPARE PARTS LIST	23
10. EXPLODED VIEW OF SPARE PARTS	27

1. SAFETY INSTRUCTION

➤ Read all safety warnings and all instructions.

Failure to follow the warnings and instructions may result in electric shock, fire and/or serious injury.

➤ Save all warnings and instructions for future reference.

The term "power tool" in the warnings refers to your mains-operated (corded) power tool or battery-operated (cordless) power tool.



1.1 Personal Safety

➤ **Stay alert, watch what you are doing and use common sense when operating a power tool. Do not use a power tool while you are tired or under the influence of drugs, alcohol or medication. A moment of inattention while operating power tools may result in serious personal injury.**

➤ **Use personal protective equipment. Always wear eye protection. Protective equipment such as dust mask, non-skid safety shoes, hard hat, or hearing protection used for appropriate conditions will reduce personal injuries.**

➤ **Prevent unintentional starting. Ensure the switch is in the off-position before connecting to power source and/or battery pack, picking up or carrying the tool.**

➤ **Carrying power tools with your finger on the switch or energising power tools that have the switch on invites accidents.**

➤ **Remove any adjusting key or wrench before turning the power tool on. A wrench or a key left attached to a rotating part of the power tool may result in personal injury.**

➤ **Do not overreach. Keep proper footing and balance at all times. This enables better control of the power tool in unexpected situations.**

➤ **Dress properly. Do not wear loose clothing or jewellery. Keep your hair, clothing and gloves away from moving parts. Loose clothes, jewellery or long hair can be caught in moving parts.**

➤ **If devices are provided for the connection of dust extraction and collection facilities, ensure these are connected and properly used. Use of dust collection can reduce dust-related hazards.**

➤ **The operators must be trained strictly and correctly, and read & understand the operation instructions of the machine correctly. If the operation instructions are not followed or the straps is placed incorrectly, the straps will be damaged and the operator will be injured.**

➤ **Before getting start with the machine, please keep your fingers away from the tension and cutting area of the machine.**

➤ **Do not use the bonded straps to carry, drag or suspend the heavy object, which may cause accidents.**



1. SAFETY INSTRUCTION

1.2 Work Area Safety

➤ **Keep work area clean and well lit. Cluttered or dark areas invite accidents.**

➤ **Do not operate power tools in explosive atmospheres, such as in the presence of flammable liquids, gases or dust. Power tools create sparks which may ignite the dust or fumes.**

➤ **Keep children and bystanders away while operating a power tool. Distractions can cause you to lose control.**

➤ **Do not operate the machine in a narrow space.**

1.3 Power Tool Use And Care

➤ **Do not force the power tool. Use the correct power tool for your application. The correct power tool will do the job better and safer at the rate for which it was designed.**

➤ **Do not use the power tool if the switch does not turn it on and off. Any power tool that cannot be controlled with the switch is dangerous and must be repaired.**

➤ **Disconnect the plug from the power source and/or the battery pack from the power tool before making any adjustments, changing accessories, or storing power tools. Such preventive safety measures reduce the risk of starting the power tool accidentally.**

➤ **Store idle power tools out of the reach of children and do not allow persons unfamiliar with the power tool or these instructions to operate the power tool.**

➤ **Power tools are dangerous in the hands of untrained users.**

➤ **Maintain power tools. Check for misalignment or binding of moving parts, breakage of parts and any other condition that may affect the power tool's operation. If damaged, have the power tool repaired before use. Many accidents are caused by poorly maintained power tools.**

➤ **Keep cutting tools sharp and clean. Properly maintained cutting tools with sharp cutting edges are less likely to bind and are easier to control.**

➤ **Use the power tool, accessories and tool bits etc. in accordance with these instructions, taking into account the working conditions and the work to be performed. Use of the power tool for operations different from those intended could result in a hazardous situation.**

1.4 Battery Tool Use And Care

➤ **Environmental Protection. Please don't discard or burn the waste batteries at will, causing environmental pollution. If you don't know how to deal with it, please consult the supplier. Be sure to use the original battery to ensure safety.**

➤ **Do not disassemble the battery. Please store the battery in a dry and frost resistant room. Storage temperature should not be higher than 50°C, please keep dry all the time.**

➤ **Do not charge the waste batteries. If you find that the battery charging is abnormal, please do not charge it by force and replace it with a new one to avoid accidents.**

[1. SAFETY INSTRUCTION]

- **Recharge only with the charger specified by the manufacturer.** *A charger that is suitable for one type of battery pack may create a risk of fire when used with another battery pack.*
- **Use power tools only with specifically designated battery packs.** *Use of any other battery packs may create a risk of injury and fire.*
- **When battery pack is not in use, keep it away from other metal objects, like paper clips, coins, keys, nails, screws or other small metal objects, that can make a connection from one terminal to another.** *Shorting the battery terminals together may cause burns or a fire.*
- **Under abusive conditions, liquid may be ejected from the battery; avoid contact. If contact accidentally occurs, flush with water.** *If liquid contacts eyes, additionally seek medical help. Liquid ejected from the battery may cause irritation or burns.*

1.5 Hazards of Incorrect Operation

Incorrect operation, excessive tension, improper use of packing straps, sudden loss of tension force due to loading of sharp objects, or breakage of straps may eventually lead to:

The operator falling down as a result of out of balance.

Personal harm as a result of the tool and the strap whipping out to the operator quickly.

Attention:

- If the load object is sharp, please add edge protection between the strap and the object.*
- Please wrap the packing straps around the object correctly.*
- In the process of operation, the operator should stand beside the machine and the strap, instead of in front and back of the machine and the strap. If the operator operates the machine by standing in a straight-line position with the tool, he may be injured by the machine or the strap that strikes forward or backward towards him due to improper operation. Keep away from bystanders during operation. Please use a strap of qualified quality recommended in this manual. A qualified strap shall have suitable width, thickness and strength. Unqualified straps may result in strap breakage during strap tensioning, causing hazards.*

1.6 Straps Dispenser

- **Please use professional straps dispenser to work with the machine.** *After finished the operation, please fold the end of the strap into the straps dispenser.*

1.7 Welding Effects

- **When it is found that the straps welding joint is unqualified(refer to 5.3 for the welding joint standard), please cut off the strap and operate again.**

[1. SAFETY INSTRUCTION]

- **Unqualified strap welding may lead to unsecure strapping, which may cause serious damage during shipping process, bringing a safety hazard.**

1.8 Correct Strap Cutting

- **Please cut off the strap with a suitable cutting tool and ensure a safe distance between the strap and the operator.** *Do not stand in a same straight line as the strap, and stay away from the loose direction of the strap, to prevent the operator from being injured by the bounced strap due to sudden breakage of the strap.*
- **Please use professional tools for cutting straps.** *Hammers, pliers, hacksaws, axes, etc. are not allowed.*

1.9 Regular Maintenance

- **Have your power tool serviced by a qualified repair person using only identical replacement parts.** *This will ensure that the safety of the power tool is maintained;*
- **Regularly maintain the tool to keep it in a good working condition;**
- **Regularly check for broken or worn parts.** *If there are broken or worn parts, please replace the parts in time before using it;*
- **It is recommended to clean the machine regularly (every day) if it is used in a dirty environment.** *Remove impurities such as debris in the tensioning and welding areas of the tool with an air gun(or other dust extraction tool), and observe it with naked eyes at the same time. If the tool is obviously damaged, please repair it and replace parts in time;*
- **The battery needs to be charged every six months if it is not used in a long time;**
- **Most parts of the tool need to be replaced and repaired when the number of strapping beats reaches more than 100,000 to avoid personal injury caused by tool failure;**
- **Please consult the supplier if you need to purchase spare and accessory parts;**
- **Do not modify the strapping machine without permission, otherwise it may cause personal injuries.**

[2. TECHNICAL PARAMETERS]

2.1 Machine Introduction

Q31 series electric battery powered strapping machine has been improved greatly in functions, performance and appearance after continuous tests and improvements by our R&D team. It overperforms competitors' similar machine in quality. Theoretically, up to 700 strap beats can be achieved for a battery charging, the maximum tension force can reach 2800N (the direct tension force of strap tension wheel can reach 4200N), and the welding time is as short as 1s.

Working modes: Fully Automatic (AUT), Semi-Automatic (SEM), Manual (MAN).

2.2 Dimensions

Length: 335mm

Width: 145mm

Height: 145mm

Weight (without battery & charger): 3.45kg

Battery weight: 0.6kg



2.3 Strap Specification

Strap material: Flat or Embossed PET(polyester) or PP (polypropylene)strap.

Strap width: 13mm-16mm; Strap thickness: 0.5-1.2mm

Please choose a strap with an appropriate size according to the strapping tool you purchased.

2.4 Strap Strength

Tension: 400N-2800N(adjustable,the tension force of the tension wheel can reach 4200N).

Tightening speed: 100-200mm/s.

Welding strength: About 75-80% of the strength of PET Strap. (depending on the quality of the straps)

2.5 Working Temperature

- The ambient air temperature is between 5°C and 45°C.
- The optimum operating temperature is between 15°C and 20°C.

[3. ATTACHMENT]

Please use the accessories/parts and maintenance tools required in this operation manual. It may cause hurt if you using the unfit accessories/parts/maintenance tools.

3.1 Battery Specification

If you need to purchase the battery in your local market, please refer to the following battery parameters and specifications:

Model: lithium battery

Voltage: 18V

Capacity: 5.0A/h (4.0A/h optional)

3.2 Charger Specification

Standard Chargers:

Input: 230V - 50/60Hz, 75W (110V optional)

Output: 10.8V-18V Max DC --- 3.5A

Charging time:

Lithium batteries 5.0A/h (4.0A/h): about 90 minutes.

3.3 One Set of Tool Kit For Free

3.4 Suspension System(optional)



3. ATTACHMENT

Figure 1: Selection 1 of suspension position during operation



Figure 2: Selection 2 of suspension position during operation



4. MACHINE APPEARANCE AND OPERATING PANEL



Light Indicates	
Blue Light	Normal Working
Red Light Flash	The battery is low, please charge it
Red Light ON	Machine failure, please power it off and check
Purple Light ON	Work Completion



[5. OPERATION STEPS]

5.1 Installation

- Please don't expose the machine in the rain or wet environment!
- For the sake of safety, the battery is not charged full when delivered.
- Please charge the battery before use. Please refer to the attached battery charger manual.

Installation/Disassembly/Charging of battery:

- The battery should be disassembled and assembled following the direction shown in the figure. When removing the battery, press the red button and move it out.
- When the battery is inserted, the battery status will be displayed for a short time.
- The battery power status is displayed by the indicator lights:
 - Flashing green light: it means the battery is being charged
 - Green light on: it means the battery on the charger is fully charged

<p>Battery Installation:</p> <p>Take out the lithium battery in the packing box and install it as shown in the figure on the right. When the battery is inserted, the power status light will be displayed for a short time.</p>	
<p>Battery Disassembly:</p> <p>Remove the battery following the direction shown in the figure. When removing the battery, move it out while pressing and holding the red button, as shown in the right figure.</p>	

[5. OPERATION STEPS]

Battery Charging:

Insert the battery to be charged into the charger slot and plug it into a power supply, as shown in the figure on the right.



⚠ Warning:

Insufficient battery power may lead to insufficient welding of the packing straps
Please cut off the strap if the strap welding is not enough!
The battery must be charged before using the machine again.

5.2 Operation Function Description

5.2.1 Operation Panel And Buttons

Start preparation:

1. Operation panel unlocking and locking:

Plug in the power supply (battery), and the machine is in the locking state, at this time any button on the operation panel is invalid.

Unlocking Method for the Operation Panel: Press the button DEC (for about 2s), and then press the Welding button B to unlock it after hearing a sound of Beep.

After parameters are set, you can also press the button DEC for 2s, and then press the Welding button to lock the operation panel after hearing a sound of Beep.



Note: The machine will enter the locking state again if no operation is performed within 30s after the tool is unlocked.

2. Waking-up from the sleep state:

The machine will enter the sleep state if no operation is carried out within 120s after the machine is unlocked, and all the indicator lights go out. All buttons will be invalid, except the button Tensioning A1. To wake up the tool, short press the button Tensioning A1 to restore it to the standby mode.

At this time, the machine can work normally. If it is necessary to modify the previously set parameters, please refer to the "Operation panel unlocking", unlocking the operation panel and then modifying the parameters.

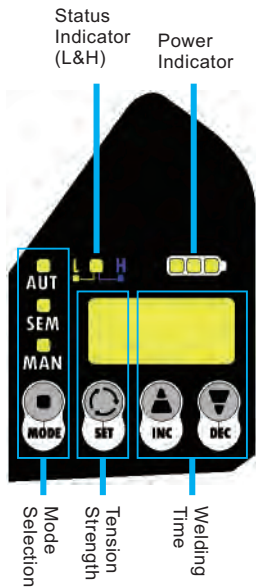
5. OPERATION STEPS



<p>Mode selection(MODE) and working status indicator:</p> <p>Operation mode selector (MODE): There are three operation modes: Manual(MAN), Semi-automatic(SEM) and Fully automatic(AUT). The corresponding indicator light will be on when a mode is selected, and indicator lights of different colors mean different working status.</p> <p>Status indicator lights: Blue light always-on: means the tool is normal, standby; Red light flashing: means insufficient power, indicating the battery has to be charged; Red light always-on: means tool failure, please power it off and check; Purple light on for a short time: indicates completion of the packing work</p>	 <p>Labels in diagram: Status Indicator (L&H) Power Indicator AUT SEM MAN MODE SET INC DEC Mode Selection Tension Strength Welding Time</p>
<p>Tension force setting(SET): 1-9 Grades; 400N-2800N</p>	
<p>Welding time setting(INC&DEC): Used to set a welding time, INC is to increase time, and DEC to shorten time, interval value: 0.5-3.5 seconds.</p>	
<p>Tensioning mode selection: Normal Mode H: The blue indicator light is on; Soft Mode L: The yellow indicator light is on.</p>	
<p>Battery indicator: Displays the remaining battery capacity (all light on means the battery full charged.)</p>	
<p>Buttons: Button A: Tension Button Button B: Welding Button</p>	
<p>Rocker lever: Holding up the rocker lever, you can lift the tension wheel; retract the strap or stop the machine in an emergency.</p>	

5. OPERATION STEPS

5.2.2 Basic Settings

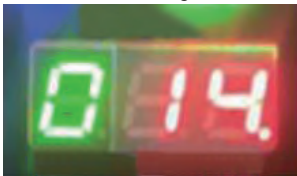

<p>Mode selection (MODE)</p>	<p>After the operation panel unlocked, you can cycle to select a mode you need by short pressing the button MODE.</p>	<p>Manual mode (MAN): Tensioning function and welding function will be operated separately. Press and hold the button Tensioning A until the set tension force is reached and then press the button Welding B for manual strap welding & cutting.</p> <p>Semi automatic mode (SEM): Long press the button Tensioning A, and the straps will be tensioned and welded one time.(The tension wheel will stop rotating if the button Tensioning A is released during the tensioning process, and at this time, the tool will start welding and cutting off the strap if the button Welding B is pressed.)</p> <p>Fully automatic mode (AUT): Short press the button Tensioning A, and the machine will automatically tension, weld and cut off the strap. Under this mode: The strap will be tensioned automatically, and will be welded and cut off automatically when the tension grade reaches the set one.</p>
<p>Tension force setting (SET)</p>	<p>After the operation panel unlocked: © Adjust the strap tension range (Grade 1-9) by short pressing the button SET. The larger the number is, the stronger the tension force will be; and the weaker on the contrary. (Grade 1 stands for the minimum tension force, and Grade 9 for the maximum.) © The default factory setting of the machine is Normal Mode H. Long press the button SET on the operation panel, and "H - -" on the digital display will flash for 3 times, which means the tool enters the Normal Mode. Then long press the button SET on the panel, and "L - -" on the digital display will flash for 3 times, which means the tool enters the Soft Mode.</p>	<p>Normal Mode (H -): Tension force range: 400-2800N (adjustable, the tension force of the tension wheel can reach 4200N.) Grade: 1-9 Instruction: This mode is used when objects to be strapped are required to be strapped relatively tightly (or when a PET strap is used). Note: in the Normal Mode, please adjust the tension force for your desired one by increasing the tension force from the minimum in sequence; and avoid the maximum grade, as the tension force at this grade is the strongest, a strap can't bear it, which will cause personal injuries of the operator.</p> 

5. OPERATION STEPS

		<p>Soft Mode (L -): Tension range: 400N-1600N Grade: 1-9 Note: This mode is used when objects to be strapped are required to be strapped relatively loosely (or when a PP strap is used).</p> 
Welding time setting (INC&DEC)	When setting the welding time, short press the button INC to increase the welding time, and short press the button DEC to decrease the welding time (One press means an increase or decrease of 0.1 seconds, and the value display interval is 0.5-3.5 seconds.)	
Operation panel locking (not in the sleep state)	<p>The machine will automatically lock its operation panel if no-operation status has lasted for 30 seconds. Pressing any button on the operation panel will not work at this time, that is, settings cannot be changed, but the machine can work normally. It is unnecessary to unlock it unless it is necessary to change the settings.</p> <p>An unlocking operation is required before parameter settings are changed each time.</p> <p>Unlocking method: Long press the button DEC (for about 2s), and then press the button Welding B after hearing a sound of Beep.</p>	
Waking up of the machine from the sleep state	The machine will enter the sleep state if no-operation status has lasted for 120 seconds, and all the indicator lights go out. All buttons will be invalid, except the button Tensioning A1. To wake up the tool, short press the button Tensioning A1 to restore it to the standby mode.	
Query of number of beats (accumulative strap beats): six digits displayed on the screen	<p>You can check six digits: After unlocking the operation panel, long press the button MODE for about 5 seconds, and the display screen will display three digits, ones place, tens and hundreds place (a decimal point at the side of the ones place) in the first page, and thousands place, ten thousands place and hundred thousands place in the second page.</p> <p>You can switch the pages in a circular manner by short pressing the button MODE. Exit and return to the main display screen by pressing the button INC or any other button.</p>	<p>First Page</p>  <p>Ones Place Tens Place Hundreds Place</p> <p>Second Page</p>  <p>Thousands Place Ten Thousands Place Hundred Thousands Place</p>

5. OPERATION STEPS

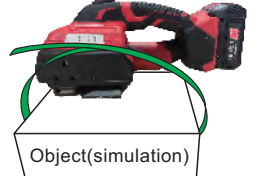
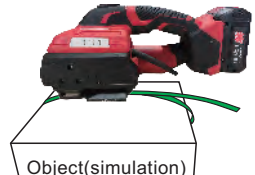
5.2.3 Strapping Operation Steps

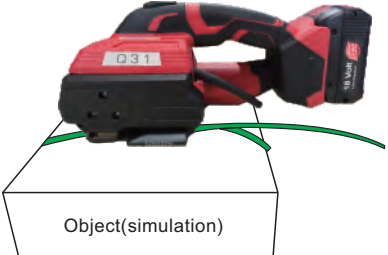
<p>a. wrap the pp/pet straps around the object to be packed: The operator faces the tool, holding the machine in his right hand, and the machine is on the right side of the operator. Place the strap around the object to be strapped in the order of upper side->front side->lower side->back side, as shown in the figure.</p> <p>⚠ Warning: Please keep the PP/PET strap away from oil, grease and other dirt when welding it, as a dirty strap cannot be welded well.</p>	<p>✓</p>  <p>Object(simulation)</p> <p>Correct Wrapping Direction</p>	<p>✗</p>  <p>Object(simulation)</p> <p>Wrong Wrapping Direction</p>
<p>b. Put the straps into the machine: After wrapping the strap around the object to be strapped properly, lift the rocker lever of the machine with your right hand, and insert the parallel overlaid straps into the tool smoothly with your left hand, and then release the rocker level.</p> <p>⚠ Note: Please tension the strap around the object as much as possible and then insert it into the tool, which can reduce the strap tensioning time of the tool, avoiding wasting electric energy.</p>	<p>✓</p>  <p>Object(simulation)</p> <p>Proper Length of Strap Left</p>	<p>✗</p>  <p>Object(simulation)</p> <p>Excessive Length of Strap Left</p>
<p>c. Tension the strap: Tension the strap to finish the strapping operation by referring to the Method for Basic Settings. Note: Manual(MAN) and Semi-Automatic(SEM) Mode: Press the tension button until the indicator light shows purple, and the tension protection does not affect the next-step operation. Automatic(AUT) Mode: Press the tension button in a short time and release.</p> <p>⚠ Warning: Keep the movement of the tool in balance during the tensioning process. Lift the rocker lever to stop working when an emergency stop is required during the tensioning process. Therefore, do not block the movement direction of the strapping tool.</p>	 <p>Object(simulation)</p> <p>Tension Completed</p>	

[5. OPERATION STEPS]

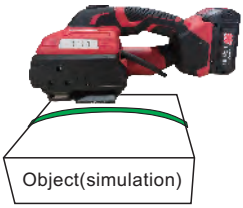
<p>d.Weld and cut off the strap: Weld and cut off the strap to finish the strapping operation by referring to the Method for Basic Settings. The purple indicator light will be on during the welding process.</p>	
<p>e.Remove the machine and complete the operation: After the welding is finished, the buzzer rings for 3 seconds and stops, indicating that the strap welding and cutting work is completed. At this time, you can remove the machine by lifting the rocker lever and moving the tool rightward and wait for a next operation.</p>	 <p style="color: blue; text-align: center;">Strap Welding & Cutting Completed</p>
<p>Remarks:</p>	<ol style="list-style-type: none"> 1. In the Automatic(AUT) Mode, only Steps a, b, c, e are required. 2. Remove the battery and then install it again, if the machine fails to work normally due to misoperation or other reasons. 3. When the strap is stuck by the machine, the battery must be pulled out first, then cut off the strap, remove the panel screw, and then remove the strap. 4.The tension protection function will start by pressing the button Tensioning continuously for 8 times, and at this time, the protection function can be cancelled by lifting the rocker lever once. 5. Note: If the rocker lever is lifted immediately after welding, the machine will give rapid sound alarms for 5 seconds due to a lack of cooling time.

5.2.4 Operation Methods for Three Modes

Manual Mode (MAN):	Long press the button Tensioning until the set tension grade is reached, and the machine will stop automatically. Then press the button Welding, and strap welding and cutting will be finished after three short sounds of "Beep", and at this time, hold the rocker lever to retract the strap and remove the machine.
Semi-Automatic(SEM):	Long press the button Tensioning until the set tension grade is reached, and the machine will automatically weld and cut off the strap. The strap welding will be finished after three short sounds of "Beep", and at this time, hold the rocker lever to retract the strap and remove the machine.
Fully Automatic(AUT):	Short press the button Tensioning until the set tension grade is reached, and the tool will automatically weld and cut off the strap. The strap welding will be finished after three short sounds of "Beep", and at this time, hold the rocker lever to retract the strap and remove the machine.

[5. OPERATION STEPS]

5.2.5 Operation Essentials For Three Modes



Item	Manual Mode(MAN)	Semi-Automatic Mode(SEM)	Full-Automatic Mode(AUT)
a. Install the battery	<ol style="list-style-type: none"> 1. Inset the charged battery into the battery slot, completed after a sound of "Click". 2. The display lights are ON, displaying all the previously set data, and the blue light is always on, going to the standby mode. 		
b. Strapping	<ol style="list-style-type: none"> 1. Place the strap around the object to be strapped. 2. Long press the button Tensioning for strap retraction until your desired tension is reached. 3. Press the button Welding for friction welding process, the purple light short on, and one long sound of "Beep", the strapping finished. 4. An emergency stop or strap retraction can be achieved by lifting the rocker lever during the strapping process. 5. The machine goes into the standby mode (the blue light always on). 	<ol style="list-style-type: none"> 1. Place the strap around the object to be strapped. 2. Long press the button Tensioning for strap retraction until the set tension is reached, and then the machine will carry out friction welding process automatically, the purple light short on, and three short sounds of "Beep", the strapping finished. 3. An emergency stop or strap retraction can be achieved by lifting the rocker lever during the strapping process. 4. The machine goes into the standby mode (the blue light always on). 	<ol style="list-style-type: none"> 1. Place the strap around the object to be strapped. 2. Short press (releasing immediately) the button Tensioning for strap retraction until the set tension is reached, and then the tool will carry out friction welding process automatically, the purple light short on, and three short sounds of "Beep", the strapping finished. 3. An emergency stop or strap retraction can be achieved by lifting the rocker lever during the strapping process. 4. The machine goes into the standby mode (the blue light always on).
c.Idle for 30 seconds	<ol style="list-style-type: none"> 1. The operation panel of the machine will be locked with a sound of "Beep" after 30 seconds without any operation. 2. Long press the key DEC (for about 2 seconds), and you can unlock it by pressing the button Welding (B1) after a sound of "Beep". (If it is not necessary to set parameters, it is not necessary to unlock the panel, because the machine can work in this case). 3. Strapping (the same as Item b). 		
d.Idle for 120 seconds	<ol style="list-style-type: none"> 1. The machine will go into the sleep state with a sound of "Beep" after 120 seconds without any operation. Any button/key is invalid, except the button Tensioning, in this case; 2. The machine can be wakened up by pressing the button Tensioning, and then enter the state of step a; 3. Strapping (the same as step b). 		
e.Red light flashing	It indicates the power is low, so replace the battery or remove the battery and charge it.		

5.3 Strapping Effect and Adjustment

5.3.1 Strap Welding Effect Judgment

It is necessary to control the welding effects after each strapping, which can be judged by visual inspection.

There are the following three situations, as shown in the figure:

<p>Welding time & effect perfect: The whole width of the strap is welded fully in the strap welding area, and the welding length is about 19mm. A little molten material is forced out on both sides, indicating that the welding time is appropriate.</p>	
<p>Welding time too short: In the strap welding area, there is no molten material forced out on both sides or only a little forced out on one side, and the whole strap width is not welded, all of which indicates insufficient welding time and insufficient welding. ⚠ Warning: The strap with insufficient welding must be cut off, adjust the welding time and operate the tool again.</p>	
<p>Welding time too long: If the welding time is too long, it will lead to strap overheating. Excessive molten material forced out on both sides of the strap in the strap welding area indicates welding time too long. ⚠ Warning: The strap with excessive welding must be cut off, adjust the welding time and operate the tool again.</p>	

5.3.2 Appropriate Parameter Adjustment

When the strapping effect is too loose or too tensioned, and the welding time is not appropriate, please adjust the parameters following the setting method to keep the strapping effect in the best condition. The tool cannot be used grudgingly, especially when the welding time deviation is too large, which may cause strap off, causing harm to the operator or products.

Machine adjustment method for different material straps(PP/PET) and different strap width:

Case 1: Machine adjustment during PP strap and PET strap conversion:

Method: Replace the cutter spring(Q-0080) on the cutter

Steps:

- First loosen the screw(Q-T509 M4×20) on the side shield (Q-3007). Remove the left side shield cover;
- Loosen the screw on the cutter (Q-0078) with an Allen key, and take off the cutter;
- Replace the pressure cutter spring(Q-0080) on the cutter: replace the pressure

cutter spring suitable for PP strap with the pressure spring suitable for PET strap. Put the cutter spring into the corresponding hole, and then install the cutter back. After installing the cutter, tighten the fixing screw on the cutter.

d. Then install back the side shield (Q-3007) and tighten the screws.

e. The method of replacing the PET strap cutter spring is the same as that of replacing the PP strap cutter spring.

Note: PP strap cutter spring: long with slightly elastic force; PET strap cutter spring: short with stronger elastic force(replacement cutter spring is included in the Kit for free).

Case 2: Machine adjustment for different strap width conversion:

Method: Replace the limit block

Steps:

- Strap width switch from 14-16mm to 10-13mm: Install Q-0042(13mm left front strap guide block) and Q-0053(13mm right front strap guide block), and then replace Q-0043(16mm back strap guide block) with Q-0041(13mm back strap guide block);
- Strap width switch from 10-13mm to 14-16mm: Remove the two parts Q-0042(13mm left front strap guide block) and Q-0053(13mm right front strap guide block), and replace Q-0041(13mm back strap guide block) with Q-0043(16mm back strap guide block)

5.3.3 Reference for Tension Force (Unit: N)

Gear	Normal mode (H)	Flexible mode (L)
1	400	400
2	900	550
3	1400	700
4	1900	850
5	2400	1000
6	2900	1150
7	3400	1300
8	3800	1450
9	4200	1600

6. WIRING DIAGRAM

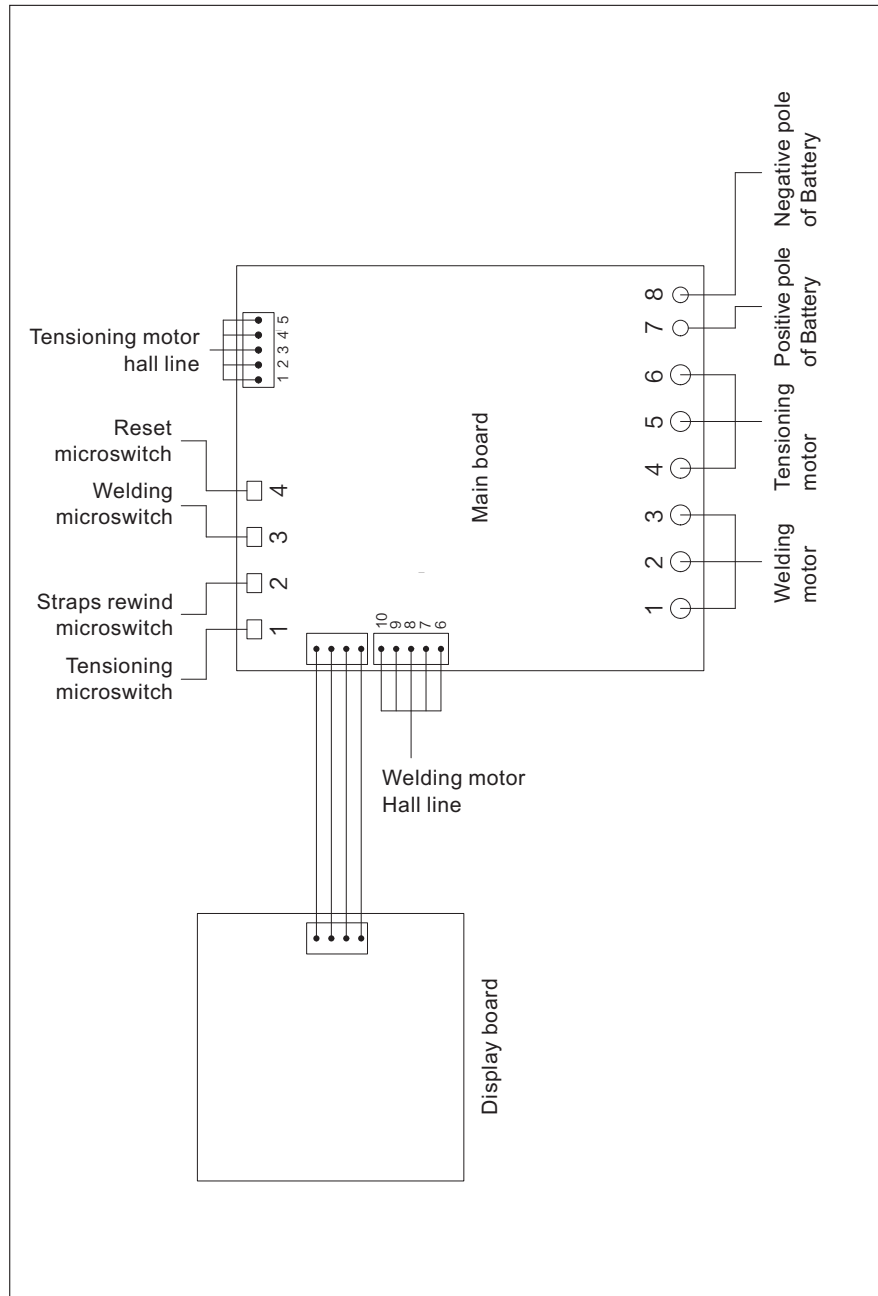

7. COMMON FAULT INDICATION AND TROUBLESHOOTING

7.1 Machine Fault Code Description

E0.2	Tension motor timeout fault (tension function not completed after more than 10 seconds)
E0.3	Short circuit fault of tension motor
E0.4	Tension motor Hall abnormal/abnormal current induction of tension motor
E0.5	Short circuit fault of welding motor
E0.6	Welding motor Hall abnormal/abnormal current induction of welding motor
E1.0	A motor is still outputting torque when the speed of the motor is 0 rpm/motor rotor locked
E1.1	Over-current protection

In case of any of the above faults, you can remove it by pressing any button and enter the standby mode. If it can't return to normal, please contact the supplier for solutions.

7.2 Common Faults and Troubleshooting

Abnormal Situation	Possible Causes	Solution
The machine doesn't work	The battery is not installed properly or short of power	Reinstall the battery or charge it
	Tension micro switch wire falling off	Re-weld/re-connect the wires
	Failure of tension micro switch	Replace the strap tension micro switch
The strap can not be retracted or pulled	Short of power possible	Check the battery power, if it is low, charge it and then use it
	Grade problem	Increase the tension grade
	Soft mode(L)	Switch the mode to be Normal Mode(H)
The machine slides forward when tensioning strap	Strap debris accumulated on the anti-sliding toothed plate	Remove debris with a drill pin in the tool kit
	The anti-sliding toothed plate worn	Replace the anti-sliding toothed plate
Tension motor idles	Strap debris accumulated in the surface toothed grooves of the tension wheel	Remove debris with a drill pin in the tool kit
	The tension wheel worn	Replace the tension wheel
	The strap too thin	Add an appropriate gasket under the anti-sliding toothed plate
Incomplete welding	Welding time too long or too short	Make adjustments by referring to 5.3 Strapping Effect and Adjustment
	Strap debris accumulated on the friction toothed plate	Remove debris with a drill pin in the tool kit
	The friction toothed plate worn	Replace the friction toothed plate
	Strap width not adjusted properly	Adjust the strap width limit block (refer to 5.3.2)
Operation completed but strap broken	Welding time too long or too short	Make adjustments by referring to 5.3 Strapping Effect and Adjustment
	The items to be strapped having excessive tension	Check if the cooling time is too short
Operation completed, but failed to remove the tool	The tension wheel cannot be lifted up	Check if it is stuck by residual strap
	Strap retraction function failure	Check if the strap retraction switch is faulty
Uneasily strap cutting	The cutter worn or the cutter spring losing its elasticity	Replace the cutter or the cutter spring

8. REPLACEMENT OF WEARING PARTS

Note: please remove the battery before repairing the machine each time.

Wearing Parts Name	Drawing No.	Replacement Procedure
Cutter	Q-0078	First remove the left shield screw, moving it away, then remove the screw on the cutter and move it away, take out the cutter and keep the cutter spring properly. Replace the cutter, install it in the reverse order.
Welding Tooth Plate	Q-A001	Remove the lower welding toothed plate by removing the fixing screw of the lower welding toothed plate; replace the toothed plate, then install it in the reverse order.
The Lower Tighen Toothed Plate	Q-2040	Remove the screw fixing the toothed plate on the base, lift the rocker lever, take out the toothed plate for replacement, and then install it in the reverse order.
Tension Wheel	Q-0010	First remove the left shield screw, moving it away, take out the tension wheel, and then take out the two bearings in the tension wheel; replace the tension wheel, and then install it in the reverse order.

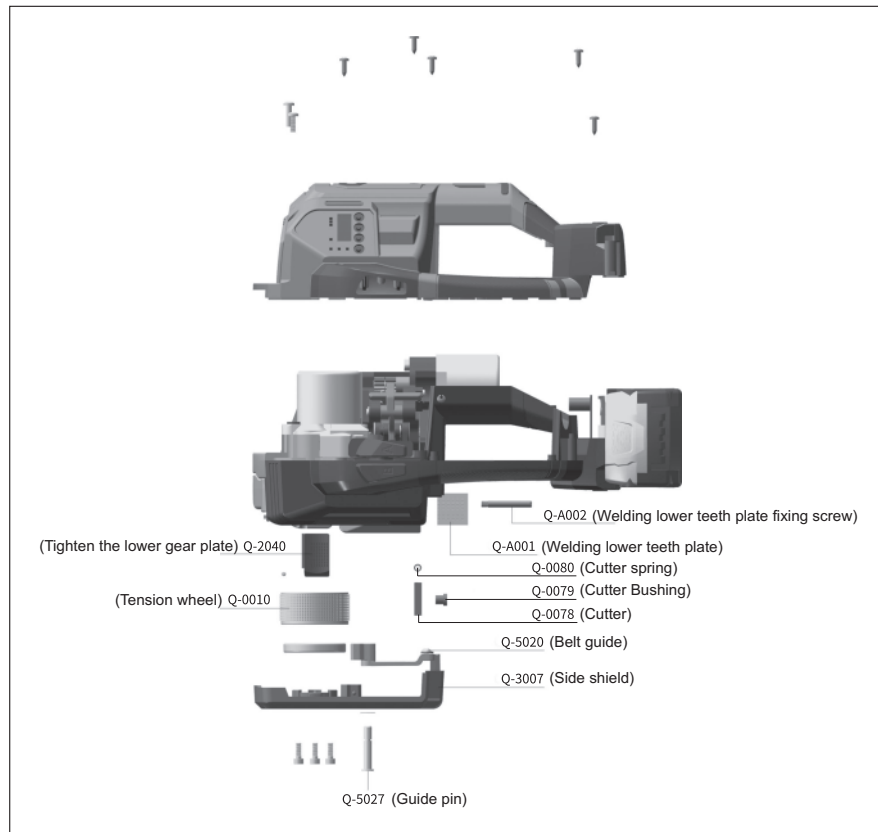

9. SPARE PARTS LIST

Table 1

Item No.	Drawing No.	English Description	Ratio
1030102202	A72	Screw M5 × 16	1
2010013130	Q-A001	Welding lower teeth plate	1
2010013147	Q-A002	Welding lower teeth plate fixing screw	1
1030102658	Q-A003	Split ring Φ4	4
2010013675	Q-A004	Pulley gasket	1
2010020285	Q-A005	Sliding gear block baffle 1	1
1030130815	Q-A006	Self tapping screw M2.5 × 6	10
1030119859	Q-A007	Nut M4	1
2011000203	Q-0004	Base rocker pin	1
2010096287	Q-0005	Planet carrier 2 Pin	3
2010096288	Q-0006	Planet carrier 2 gear	3
2010096289	Q-0007	Planet carrier 2	1
2011000194	Q-0008	Slide spring fixing pin	1
2010096290	Q-0010	Tension wheel	1
2010096291	Q-0011	Planet gear of tension gear	3
2010100170	Q-0019	Fusion spring fixing sleeve-1	1
2015000503	Q-0020A	Welding spring fixing sleeve B	1
2011000198	Q-0026	Handle pin	1
2010100174	Q-0027	Sector gear	1
2010100175	Q-0028	Cam disc	1
2011000201	Q-0031	Limit thimble shaft	1
2011000202	Q-0032	Pin 1	3
2011000204	Q-0040	Welding spring fixing pin	1
2010900064	Q-0041	13mm back strap guide block	1
2010900065	Q-0042	13mm left front strap guide block	1
2011000207	Q-0043	16mm back strap guide block	1
2011000186	Q-0052	13mm right back strap guide block	1
2011000187	Q-0053	13mm right front strap guide block	1
1030126719	Q-0077	Welding limit spring	1
2011000213	Q-0078	Cutter	1
2011000214	Q-0079	Cutter bushing	1
1030126721	Q-0080	Cutter spring	1
1030126722	Q-0098	Return spring of welding fixture	1
1030126723	Q-0099	Thimble shaft spring	1
2010096315	Q-0122	Metal insert 1	2

[9. SPARE PARTS LIST]

Continued

Item No.	Drawing No.	English Description	Ratio
2010096316	Q-0123	Metal insert 2	2
1030126726	Q-0125	Welding button spring	2
2011000225	Q-2021	Welding chute	1
2011000226	Q-2022	Welding tooth block	1
2060074516	Q-2023	Connecting rod	1
2011000227	Q-2024	Briquette	1
2011000236	Q-2025	Eccentric shaft (1.1)	1
2011000237	Q-2040	Tighten the lower gear plate	1
2010100168	Q-2041	Base rocker	1
2011000235	Q-2042	Welding drive pin	1
1021605521	Q-2051	Micro switch zippy (right outlet)	3
2015000107	Q-2061	Reset the thimble shaft	1
1030128977	Q-3003	Bracket 1	1
1030128978	Q-3004	Bracket 2	1
1030128979	Q-3005	Switch A	1
1030128980	Q-3006	Switch B	1
1030128981	Q-3007	Side shield	1
1030130954	Q-3008A	Circuit board cover	1
1030130955	Q-3008B	Lower cover of circuit board	1
1030130270	Q-3S001	Left housing	1
1030130271	Q-3S002	Right housing	1
1030130272	Q-3S009	Handle	1
2010100264	Q-S3012	Body seat	1
2015000512	Q-3S023	Tighten the motor mounting plate	1
2015000115	Q-5008	Ratchet wheel	1
2015000112	Q-5009	Gear 1	1
2015000113	Q-5010	Double gear	1
2010100240	Q-5011	Welding mount	1
2015000171	Q-5013	Welding motor mounting plate	1
2015000116	Q-5014	Large synchronous pulley	1
2015000283	Q-5014A	Synchronous pulley	1
2010900075	Q-5016	Reset lever	1
2010900076	Q-5017	Block bar	1
2018000152	Q-5018	Pin shaft	1
2018000153	Q-5019	Welding spring fixing pin	1

[9. SPARE PARTS LIST]

Continued

Item No.	Drawing No.	English Description	Ratio
2010900077	Q-5020	Belt guide	1
2010900078	Q-5021	Welding framework	1
2015000155	Q-5027	Guide pin	1
2015000121	Q-5028	Base guard	1
2015000118	Q-5031	Cam	1
2015000114	Q-5033	Tighten the motor gear	1
2015000150	Q-5034	Tension motor	1
1030128219	Q-5035	Handle return spring	1
1021606068	Q-5037	Circuit board	1
2015000172	Q-5039	Pin 1	1
2015000117	Q-5041	Internal gear	1
2010100506	Q-6020	Toggle bar	1
2015000196	Q-6022	Welding reverse gear	1
2015000197	Q-6023	Welding motor gear	1
2015000194	Q-6024	Welding motor	1
1030129657	Q-6038	Limit clip spring	1
2015000281	Q-6050	Hook (optional)	1
1021402953	Q-T005	One way needle roller bearing HF0608	2
1021402954	Q-T007	Bearing 61807-2Z	2
1021403742	Q-T009	Needle roller bearing HK1015	1
1030126733	Q-T014	Set screw M4 × 20	1
1030126734	Q-T015	Set screw M8 × 6	1
1030126735	Q-T016	Set screw M12 × 8	1
1030126739	Q-T019	Screw M4 × 8	2
1030126745	Q-T026	Screw M4 × 25	4
1030126746	Q-T027	Countersunk screw M4 × 6	2
1020610550	Q-T046	Charger	1
1020610549	Q-T050	Battery	1
1030118355	Q-T206	Cylindrical pin Φ 3 × 8	2
1030127414	Q-T207	Screw M3 × 6	1
1030128551	Q-T212	Screw M4 × 10	4
1030127621	Q-T215	Equal height bolt M5- Φ 6-10	2
1030131499	Q-T215A	Equal height bolt M5- Φ 6-8	2
1030128552	Q-T218	Cylindrical pin Φ4 × 16	1
1030126338	Q-T219	Screw M4 × 16	1

[9. SPARE PARTS LIST]

Continued

Item No.	Drawing No.	English Description	Ratio
1021510270	Q-T223B	Timing belt MXL-65 teeth-12mm	1
1021400502	Q-T224	NSK 686ZZ(6*13*5)	1
1030129251	Q-T235	Pearl cotton 410 * 270 * 180	1
1030129259	Q-T236	Inner carton (440 * 280 * 180)	1
1030129676	Q-T301	PVC panel	1
1030128224	Q-T501	Screw M4 × 12	7
1021401167	Q-T502	NSK 6800ZZ (10-19-5)	1
1021403744	Q-T503	NSK 4FC-6LH (06-10-12)	1
1030128225	Q-T504	Set screw M3 × 3	1
1030130817	Q-T505A	Self tapping screw M3.5 × 12	5
1030128227	Q-T506	Screw M3 × 12	1
1030128091	Q-T507	Countersunk screw M5 × 12	2
1030128553	Q-T508	Stainless steel flat gasket M6 × 12 × 0.2	4
1030128230	Q-T509	Screw M4 × 20	3
1030128554	Q-T510A	Screw M4 × 12	2
1030129660	Q-T601	Stainless steel flat gasket M6 * 9 * 0.3	1
1021403842	Q-T602	One way needle roller bearing HF0810	1
1030128522	Q-T608	Snap ring for hole φ 15	1
1030130369	Q-T611	Stainless steel flat gasket M6 * 9 * 0.2	1
1030130370	Q-T612	Stainless steel flat gasket M6 * 9 * 0.5	1
1030126739	T021	Screw M4 × 6	6
1030126746	T021A	Countersunk screw M4 × 6	1
1030105808	T023	Screw M4 × 8	4
1030130818	T1079A	Screw M4 × 10	2
1030130820	T1091A	Countersunk screw M3 × 8	4
1030100433	T1094	Steel ball Φ 5	8
1020608827	T1111	Microswitch D2F-01FL	1
1021400712	T501	Bearing NSK608-ZZ (8-22-7)	1
1021401563	T502	Bearing NSK619-6Z (6-15-5)	3
1021401582	T503	Bearing NSK626-ZZ (6-19-6)	1
1021401565	T504	Bearing NSK627-ZZ (7-22-7)	2
1031012719	T611	Snap ring for hole Φ 22	2
1030126918	T631	Shaft ring Φ 10	2
1030116838	TD34	Set screw M3 × 5	1
1021403753	T1104A	Bearing JNS NK10 / 12	1

