

L-Clip 200

A BUMP-STYLE CASE SEALER

EdgeTec
AUTOMATION



The L-Clip 200 is designed to run tape widths of 2 inches.

The machine can be configured for single or multiple tape heads!

The L-Clip 200 is designed to seal a wide variety of boxes such as five-panel folders, full overlap, telescoping, tuck fold, roll end tuck top, and custom boxes.

The L-Clip 200 is a bump-style machine where the operator presses the box against the machine's cover to activate the tape head mechanism, automatically applying an "L" clip of tape to the edge of the box.

EdgeTec L-Clip machines can run a wide variety of tape styles, widths, and rolls. Intuitive to use and fast to operate, EdgeTec's L-Clip allows operators to quickly make consistent, secure corner closures with no tape waste.

L-Clip 200 Taping Configurations

The L-Clip 200 can be configured with one or more tape heads. Multi-head units have a head-to-head minimum distance of 8.75 inches.

Single Head



Dual Head



Triple Head

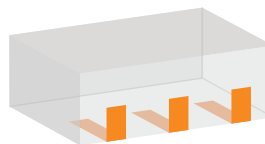

Run your preferred tape style and roll size.



Apply up to 30 clips per minute.



Easy to learn.
Quick to operate.

L-Clip 200 - Single Head

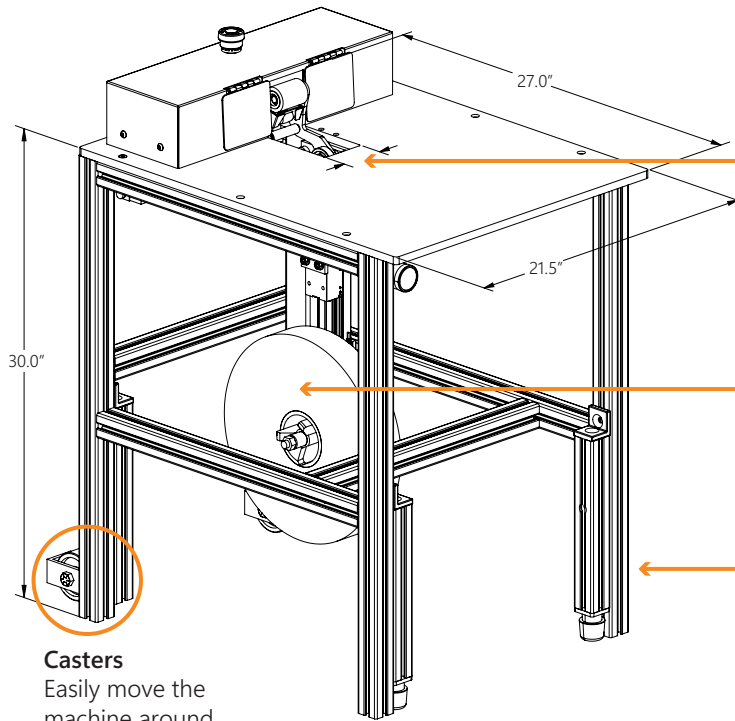

Tabletop Opening
Opening for tape head operation, 3".

Machine-Length Rolls
Easily accommodates 1000 yard tape rolls.

Adjustable Height
Tabletop height adjustable 30" - 36".

Casters
Easily move the machine around the workspace.

Need more tape heads?

The L-Clip 200 can be configured with additional heads with a head-to-head minimum distance of 8.75 inches.

Adjustable tape legs

For shorter boxes, the L-Clip 200 can be configured to shorten the vertical or horizontal tape leg to lengths between 0.5" and 2".

No air?

Upgrade to the all-electric L-Clip. The same high-quality taping, no compressed air required.

L-Clip 200 Standard Machine Specifications

Machine Type	Bump-style L-Clip tape application
Machine Makeup	Framework: Extruded aluminum Tabletop: .500" thick SANALITE® HDPE Professional-grade industrial components
Working Height	Tabletop height is adjustable between 30" - 36".
Tabletop Sizes	Standard Single Head Unit: 21.5" wide x 27" deep Standard Dual Head Unit: 32.5" wide x 27" deep Narrow Single Head Unit: 18.25" wide x 27" deep Tabletops can be customized for your working or packaging space.
Tape Heads	Multi-head units have a standard spacing of 10.5" between tape heads. Positioning can be customized down to 8.75" or increased with no upper limit.
Tape Leg Length	Standard machine applies 2.5" on the vertical box wall and 2.5" on the horizontal box wall with a tolerance of ± 0.063 ".
Tape Styles	Filament, BOPP, Flat Back, PVC
Tape Sizes	Tape widths of 2" (48mm) Accepts 1000 yd (914 m) machine-length rolls
Air Requirements	90 PSI clean compressed air
Electrical Requirements	110 VAC, 50/60Hz, 1 Phase Power or 220VAC 50/60Hz, 1 Phase Power

Box Specifications

Minimum Box Width	All machines: 3.25"
Minimum Box Height	Standard machines: 2.5" Machines can be customized for 0.5" tall boxes.

Optional Features

Box Guide with Flap Closer	A side guide ensures tape is applied to the same location. A spring-loaded arm assists in box folding and holds down the top flap while taping.
Low Profile Taping	The vertical tape leg is reduced to apply smaller lengths of tape for boxes less than 2.5" tall.
Guarding	Clear Lexan sides and interlocked door are added below tabletop to limit access to machine's moving components.
Ball Table	Allows for easy movement of heavy boxes.
Washdown Machine	A machine with a stainless-steel frame designed for full washdown. Ideal for food processing plants.
Inline Air Filter	For situations where clean compressed air is not always available.
Lag Legs	Swaps out castor wheels with lag point legs made from 11 gauge sheet metal. Tabletop height adjustment is the same.
Variable Tape Legs	Vertical and horizontal tape legs can be adjusted for any combination of 1", 1.5", and 2" tape legs.
All-Electric	The same high-quality taping machine, no compressed air needed.