



INSTRUCTIONS
MANUAL

ADHESIVE
MELTER
SF10 & SF20
RANGE



Published by:

Focke Meler Gluing Solutions, S.A.

Pol. Arazuri-Orkoien, c/B, nº3 A
E-31170 Arazuri - Navarra - Spain
Phone: +34 948 351 110
info@meler.eu - www.meler.eu

A Focke Group Company

Edition may 2020

© Copyright by Focke Meler

All rights reserved. Its reproduction, diffusion or use by electronic or other means of all or any part of this document without the express authorization of its owner is strictly prohibited.

The specifications and information contained in this manual may be modified without prior notice.

This manual is a translation of the original that was written by Focke Meler Gluing Solutions, S. A. in english language. If there is any discrepancy between the different versions of this manual, the original written in the english language shall prevail. Focke Meler Gluing Solutions, S. A. shall not be liable in any way for any damages and/or losses that may be directly or indirectly derived from discrepancies between the original version of the manual and this translation.

TABLE OF CONTENTS

1. SAFETY GUIDELINES	1-1
General	1-1
Symbols	1-1
Mechanical components	1-2
Electrical components	1-2
Hydraulic components	1-2
Pneumatic components	1-2
Thermal components	1-3
Materials	1-3
Noise emission declaration	1-3
Intended use	1-4
Limited use	1-4
2. INTRODUCTION	2-1
Description	2-1
Modes of operation	2-2
Melter identification	2-2
Main components	2-3
Control card components	2-4
Pumping control card components (optional)	2-5
SF range	2-6
Option accessories	2-6
Low level detector	2-6
Variable speed box	2-6

3. INSTALLATION	3-1
Introduction	3-1
Installation requirements	3-1
Dimensions	3-1
Electrical Consumption	3-2
Other factors	3-3
Unpacking	3-3
Contents	3-3
Mounting the equipment	3-3
Electrical power connection	3-4
2-phases 200-240 VAC without neutral connection	3-4
3-phases 200-240 VAC without neutral connection	3-5
Hose and applicator connection	3-5
Parameter Programming	3-6
Programming working temperatures	3-6
Selecting the overheating value	3-6
Keeping a component on display	3-7
External I/O connections	3-8
Temperature ok	3-9
External standby	3-9
Low level (optional)	3-10
Output disabled	3-10
Pumping external permission	3-11
Variable speed box optional intallation	3-12
Starting up the motor (ok ext)	3-12
Motor speed set point reference (ref ext)	3-12
Failures output in pump control card	3-13
LAY OUT PUMP CONTROL BOARD	3-13

4. MELTER OPERATION	4-1
General information	4-1
Filling the tank	4-2
Starting up the melter equipment	4-2
Melter equipment displays	4-3
Displaying the temperature for each component	4-4
Alarm displays	4-4
Display and adjustment of the working speed	4-5
Temperature adjustment	4-6
Programming the applicator parameters	4-7
Programming process	4-7
Timer to switch between ON - Standby - OFF modes	4-11
Password to access parameter programming	4-12
Total equipment service hours counter	4-12
Counter that warns of the need to change the adhesive agent filter	4-13
Setting the clock	4-14
Programming the current day and hour	4-14
Programming equipment activation/deactivation	4-15
Disabling the equipment activation/deactivation program	4-16
Programming the equipment's standby function activation/deactivation	4-16
Disabling the equipment standby function programming	4-17
Special function buttons	4-18
Pumping control (Optional)	4-19
Starting up the pump control card	4-19
Pumping safety measures	4-19
Password security	4-20
LED indicators	4-21

Modes of operation	4-22
Mode of operation with internal pumping control and internal speed control	4-22
Mode of operation with internal pumping control and external speed control	4-23
Mode of operation with external pumping control and internal speed control	4-24
Mode of operation with external pumping control and external speed control	4-25
User configuration menu	4-26
Displaying alarms and reset function	4-27
Maximum rpm alarm	4-27
Minimum rpm alarm	4-27
Variator alarm	4-27
Configuring speed ramp	4-28
Programming speed ramp	4-29
Current Vin voltage display	4-30
Regulating the bypass valve	4-30
Adjusting the manual valve	4-30
Turning off the melter equipment	4-30
5. MAINTENANCE	5-1
Equipment cleaning	5-1
Removing exterior panels	5-2
System depressurisation	5-2
Access to distributor and pump gear- motor	5-2
Access to the electrical connections box of the gear-motor	5-3
Gear-motor disassembly	5-3
Filter maintenance	5-4
Cleaning the tank	5-5
Changing adhesive type	5-5
Cleaning burnt adhesive	5-5
Emptying the tank	5-6

Pump maintenance	5-6
Inspecting for leaks	5-6
Gear motor maintenance	5-7
Cleaning the motor fan	5-7
Checking the lubricant	5-7
Recommended lubricants	5-7
Safety Thermostat	5-7
6. TECHNICAL CHARACTERISTICS	6-1
Generals	6-1
Dimensions	6-2
7. ELECTRICAL DRAWINGS	7-1
8. SPARE PARTS LIST	8-1
A. TANK ASSEMBLY	8-2
B. DISTRIBUTOR	8-3
D. GEARED MOTOR-PUMP ASSEMBLY	8-4
E. ELECTRIC ASSEMBLY	8-5
E. ELECTRIC ASSEMBLY	8-6

This page is intentionally left blank.

1. SAFETY GUIDELINES

General

The information contained in this section applies not only to everyday equipment operation, but also to any procedure carried out on it, whether for preventive maintenance or in the case of repairs and the replacement of worn out parts.

It is very important to observe the safety warnings in this manual at all times. Failure to do so may result in personal injury and/or damage to the equipment or the rest of the installation.

Before beginning work on the equipment, read this manual carefully, and in case of any doubt, contact our Technical Service Center. We are available for any clarification that you might need.

Keep manuals in perfect condition and within reach of personnel that use the equipment and perform maintenance on it.

Also provide necessary safety material: appropriate clothing, footwear, gloves and safety glasses.

In all cases, observe local regulations regarding risk prevention and safety.



Symbols

The symbols used on both the melter/applicator equipment and in this manual always represent the type of risk we are exposed to. Failure to abide by a warning signal may result in personal injury and/or damage to the equipment or the rest of the installation.

Warning: Risk of electrical shock. Carelessness may produce injury or death.



Warning: Hot zone with high temperatures. Risk of burns. Use thermal protective equipment.



Warning: System under pressure. Risk of burns or particle projection. Use thermal protective equipment and glasses.



Warning: Important information for the correct use of the system. May include one or several of the previous hazards, and therefore must be kept in mind to avoid damage and injury.



Warning: Dangerous area. Risk of entrapment. Carelessness may produce injury or death.



Mechanical components



The hot-melt installation, which is installed to this device, requires moving parts that can cause damage. Use the equipment correctly, and do not remove the safety guards while the equipment is in operation; prevent the risk of possible entrapment due to moving mechanical parts.



Do not use the equipment if the safety devices are not in place or appear to be inadequately installed.

For maintenance or repair operations, stop the movement of moveable parts by turning off the main switch.

The device has no moving mechanical parts, so it does not pose risks to consider in this section.

Electrical components



The system works with single-phase or three-phase current of a certain power. Never handle the equipment with the power connected, as this may result in powerful electrical shocks.

The installation must be correctly grounded.



The installation's power cable conductors must match the required electric current and voltage.

Periodically inspect the cables to check for crushing, wear and tear, as well as to prevent tripping and falls as a result of their placement.

Although the system meets EMC requirements, it is inadvisable to use devices that transmit high levels of radiation, i.e., mobile phones or soldering equipment in their vicinity.

Hydraulic components



As this is a pressurized system, precautions related to this type of equipment must be observed.

Before each operation, always make sure that the adhesive circuit is completely free of pressure. There is a high risk of hot particle projection, along with the corresponding danger of burns.

Use caution with the residual pressure that may remain in the hoses when the adhesive cools. When reheated, there is a risk of hot particle projection if the outputs are left open.

Pneumatic components



Some equipment uses compressed air to 6 bar pressure. Before any manipulation, please ensure that the circuit has lost fully air pressure. The risk of projection of particles at high speed can cause injury to a certain severity.

Extreme precautions with the residual pressure that could be contained in the circuit, before disconnecting any pneumatic feeding tube.

Thermal components

The entire system works with temperatures that can exceed 200°C (392°F). The equipment must be operated using adequate protection (clothing, footwear, gloves and protective glasses) that completely cover exposed parts of the body.

Keep in mind that, due to the high temperatures reached, the heat does not dissipate immediately, even when the power (in this case, electric) source is disconnected. Therefore, use caution, even with the adhesive itself. It may remain very hot, even in a solid state.

In case of burns:

1. If the burn is the result of contact with melted adhesive, do not try to remove the adhesive material from the skin. Do not try to remove it once it has solidified either.
2. Cool the affected area down immediately with lots of cold and clean water.
3. Seek medical attention as soon as possible either from the company's medical service or the nearest hospital. Provide the medical staff with the Safety Information Sheet of the adhesive.



Materials

Meler systems are designed for use with hot-melt adhesives. They should not be used with any other type of material, and especially not with solvents, which may cause personal injury or damage to internal system components.

Some units are specifically designed to use polyurethane reactive (PUR) hot-melt adhesives. Using PUR on a unit that is not prepared for that purpose may cause severe damage to the unit.

When using adhesive, follow the corresponding guidelines found in the Technical and Safety Sheets provided by the manufacturer. Pay special attention to the advised work temperatures in order to prevent adhesive burning and degradation.

Ventilate the work area adequately in order to remove the vapors produced. Avoid the prolonged inhalation of these vapors.

Always use original Meler components and replacement parts, which guarantee the correct system operation and service.



Noise emission declaration

The A-weighted emission sound pressure level (L_{pA}) of the unit in operation does not exceed 70 dB(A) under any circumstances.

The maximum C-weighted sound pressure level (L_{pCpeak}) and the A-weighted sound power level (L_{WA}) do not exceed values worthy of mention and thus do not represent a specific risk that must be taken into account.



Intended use

The equipment are designed to be used in the following conditions:

- Hot-melt adhesive fusion and pumping at temperatures up to 200 °C (392 °F). Consult with Meler technical service to operate with higher working temperatures.
- Use of equipment with Meler accessories.
- Installation of equipment according to the security regulations currently in force and the instructions provided in this manual (anchoring, electrical connection, hydraulic connection, etc).
- Use of equipment in non-explosive, non-chemically aggressive environments.
- Use of equipment following the safety instructions indicated in this manual, as well as on the labels accompanying the equipment, using adequate means of protection during each mode of operation.

Limited use

The equipment should never be used under the following conditions:

- Use with reactive polyurethane or any other material that might cause safety or health risks when heated.
- Use of equipment in environments where cleaning is necessary using water jets.
- Use of equipment to heat or melt food products.
- In potentially explosive atmospheres, aggressive chemical environments or outdoors.
- Use or operation without adequate safety protection.
- If the person in question does not have the necessary training to use the unit or to apply all of the necessary safety measures.



Note: Do not modify the equipment or use components that were not supplied by Meler. For any modification of a component of the equipment or part of the installation, you must firstly consult the After-Sales Service

2. INTRODUCTION

In this manual you will find information about the installation, use and maintenance of the hot-melt adhesive melter SF10 and SF20 range of hot-melt adhesive melters.

Most of the photographs and illustrations that appear in this manual refer to the SF10 melter. This model has been used as a reference for writing this manual as its main characteristics, with the exception of the tank capacity and the connection outputs are the same as those in the rest of the equipments of the serie.

Description

These melters are designed for use with Meler hoses and applicators in hot-melt adhesive applications. Their different variations – line, coating or swirl-spray – cover a wide range of applications, being very versatile in all markets where they are used.



Modes of operation

These melters may be used in all of the following modes:



Work mode_ The hot-melt melter keeps materials hot at the pre-selected temperature indicated on the display. The pump is kept activated, waiting for the consumption command when one or more applicators are activated.

Internal control of pumping_ In this mode of operation, the user has full control of pumping . The speed of the pump rotation is fixed.

External control of pumping_ This mode of operation is performed through external pumping . The speed of the pump rotation is fixed.

Whith the variable speed box accessory (optional) it is posible the next operation modes:

Internal control of pumping and speed_ In this mode of operation, the user has full control of pumping and the set speed of the pump rotation.

Control of internal pumping and external speed_ This mode of operation is performed through internal pumping control and speed control by means of an external 0-10 V signal sent from the main machine.

Control of external pumping and internal speed_ This mode of operation is performed through external pumping control and manual speed control.

Control of external pumping and speed_ In this working mode, both pumping and speed are controlled from the main machine. Speed is controlled by means of an external 0-10 V signal sent from the main machine.

Standby mode_ The hot-melt melter remains in a resting state, with the materials kept at (programmable) temperature values below the pre-selected value. The pump remains deactivated.

Alarm mode_ The hot-melt melter detects a malfunction and warns the operator of this event. The pump remains deactivated.

Stop mode_ The hot-melt melter remains off, without heating the materials and with the pump deactivated. The electrical and pneumatic supply remains activated between the network and the system, however.



Melter identification

When placing orders for replacement parts or requesting help from our Technical Service, you should know the model and reference number of your hot-melt melter.

This and other technical information will be found on the identification plate located on the side of the lower part of the hot-melt melter.

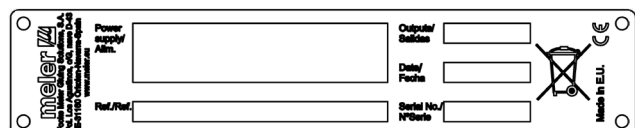

Main components

1. Front control card.
2. Access door to the electric area.
3. External pump switch.
4. Main switch ON/OFF.
5. Variable speed box connector.
6. Tank access lid.
7. Mechanical by-pass valve pressure control.
8. Hose output distributor (4 hydraulic connections).
9. Hose-applicator electrical connections.
10. Electrical supply input.
11. Pumping motor.
12. Pumping control card (Variable speed box. Optional).



Control card components

1. Tank indicator LED.
2. Applicator indicator LED.
3. Temperature set point.
4. Real temperature.
5. ON/OFF switch.
6. Standby function.
7. Temperature OK LED.
8. Time scheduling.
9. Left/right button - channel selection.
10. Up/down button - temperature modification.
11. Hose indicator LED.

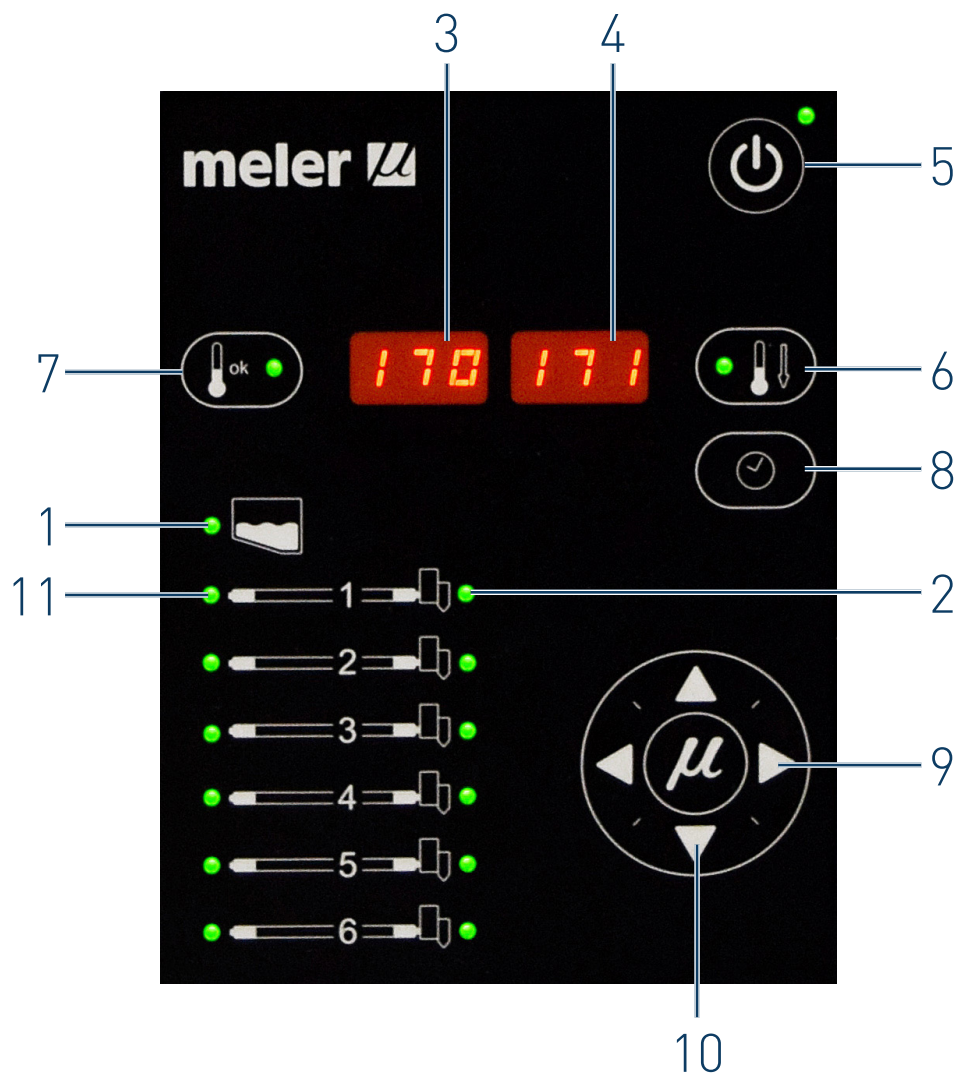

Pumping control card components (optional)

1. Main switch ON/OFF.
2. External start-stop LED.
3. External speed control LED.
4. Pumping permission LED.
5. Up/down arrow keys for selecting values.
6. Left/right arrow keys for selecting options.
7. Speed ramp steps display screen.
8. Speed ramp value selection LEDs (voltage/speed).
9. Voltage/ pump speed/ errors display screen.
10. Pumping control (internal/external) selection.
11. Pumping speed (internal/external) selection.
12. Voltage value display of the external signal of the speed control.

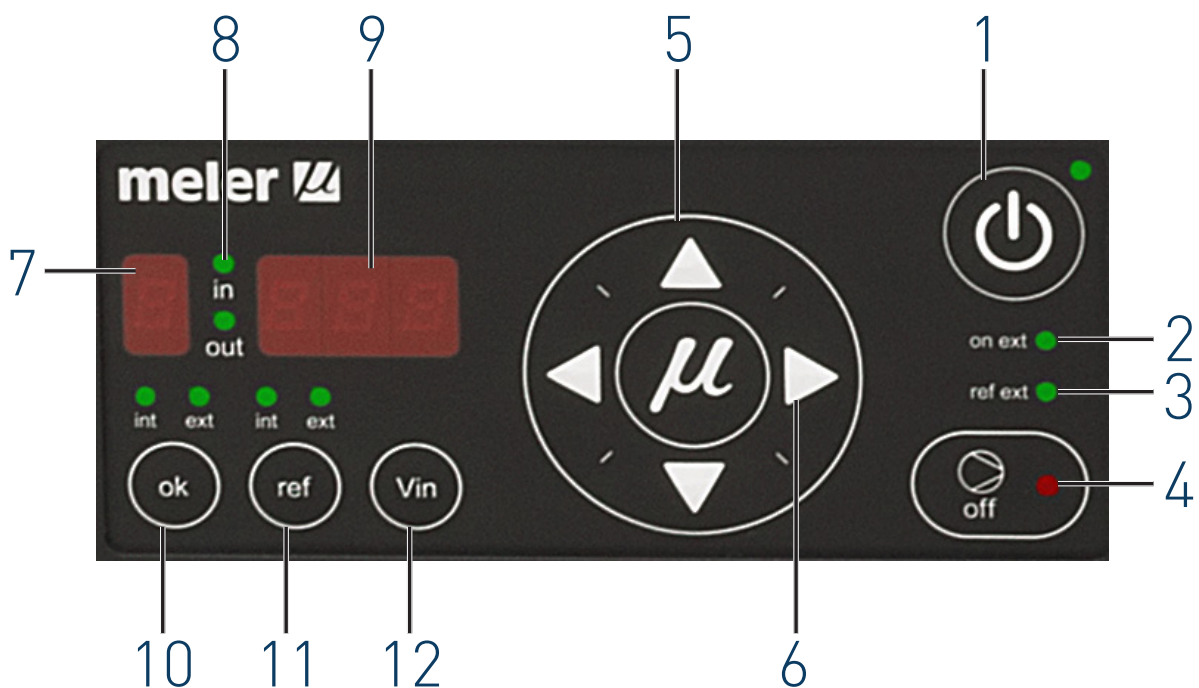

SF range

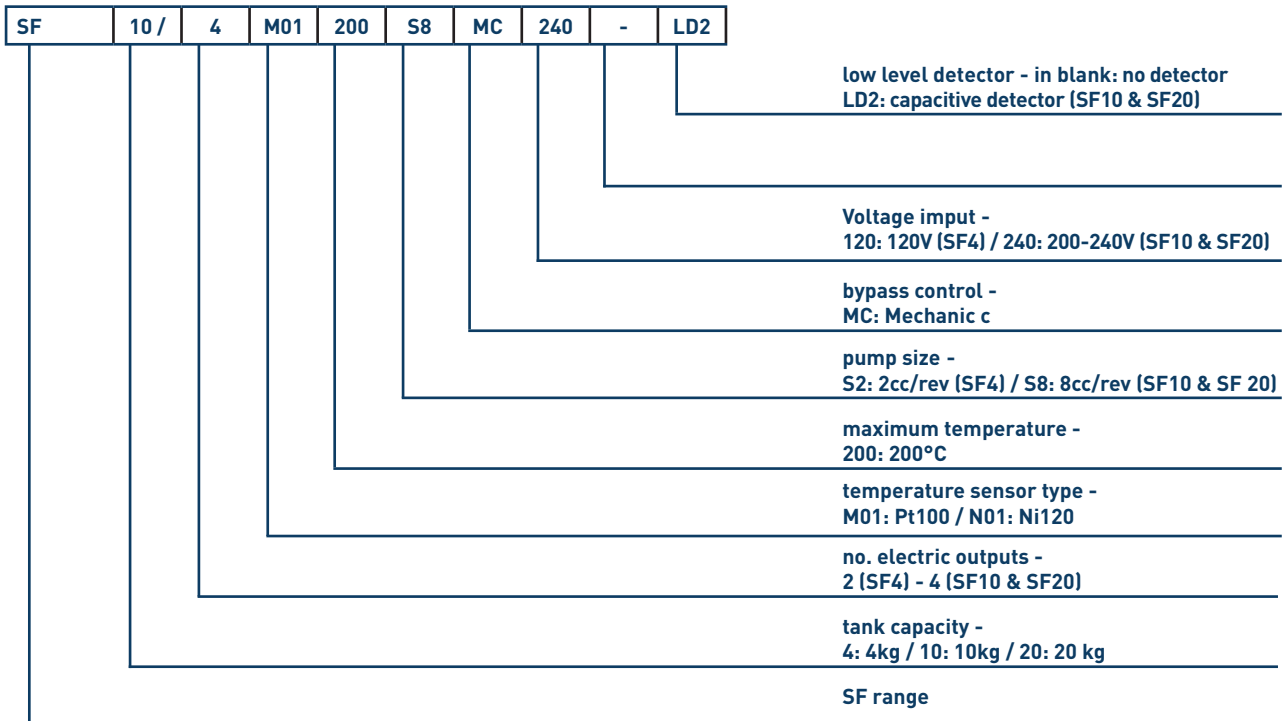

- SF10 and SF20 melters are prepared by default for the capacitive detector.
- SF10 and SF20 melters includes an adapter to connect it to 3 phases 230 without neutral.

Option accessories

If some of the different machine configuration options have been chosen, it will be necessary to purchase the following accessories:

Low level detector

To detect a low level of melted adhesive, there is a choice a capacitive detector.

The capacitive detector is electrically supplied by the melter, but the unit does not stabilize the signal nor report the level status.

Variable speed box

SF10 and SF20 melters are prepared by default for being upgraded with an external electrical board for converting it into a variable speed melter. This external box has to be ordered separately.

3. INSTALLATION

Warning: The melters are equipment with current technology and with certain foreseeable risks. Therefore, only allow qualified personnel with enough training and experience to use, install or repair this equipment.



Introduction

The melters of this serie are delivered with all the materials necessary for their installation. However, some components must be provided by the user himself, according to the location and connections in each particular installation:

- Anchoring screws for the melter equipment.
- Power cord and plug for electrical power.
- Pneumatic pipe and connection to the compressed air system.
- Multicore cable for external electrical control.
- Optionally, a gas ventilation system.

Installation requirements

Before installing melter equipment, we must make sure that the space assigned to it permits installing, connecting and using the entire system. Similarly, we must check to see that the electrical and pneumatic supplies meet the necessary requirements of the melter equipment being installed.

Dimensions

Item	Description	Dimensions
A	EQUIPMENT LENGTH	SF10 770 mm / 30.31 in SF20 770 mm / 30.31 in
B	EQUIPMENT WIDTH	SF10 395 mm / 15.55 in SF20 395 mm / 15.55 in
C	EQUIPMENT HEIGHT	SF10 510 mm / 20.07 in SF20 605 mm / 23.81 in
D	EQUIPMENT HEIGHT WITH LID OPEN	SF10 940 mm / 37 in SF20 1025 mm / 40.35 in

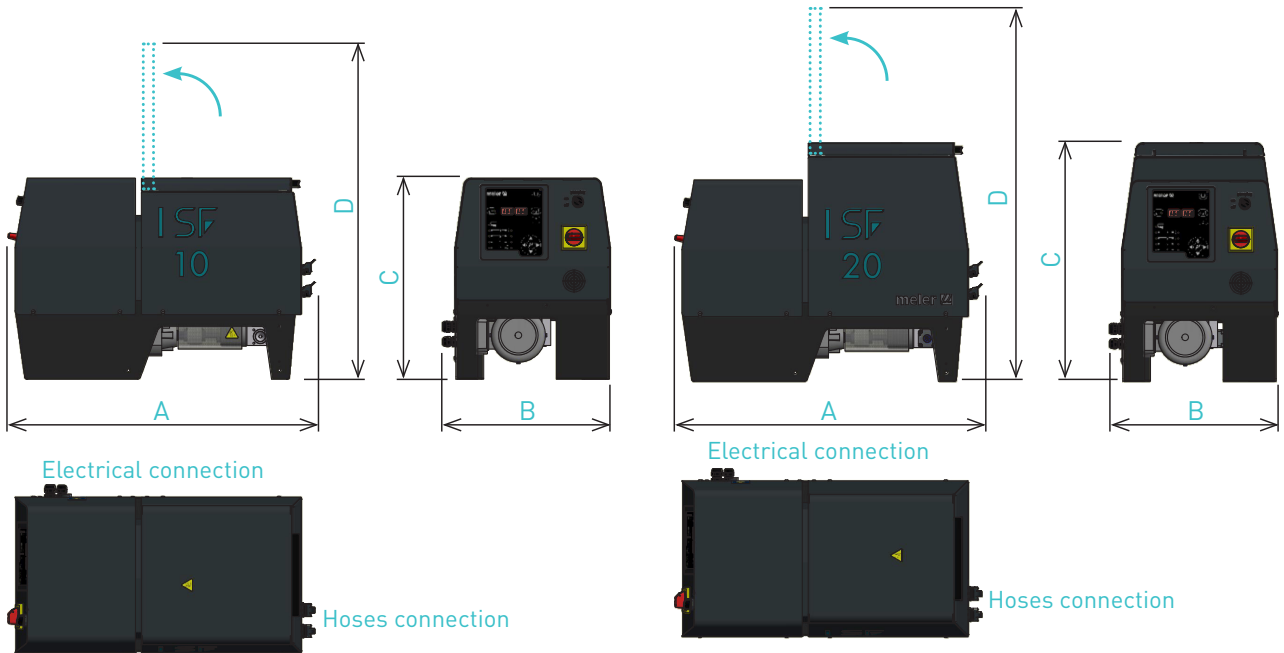

Electrical Consumption

In order to install a melter equipment of this serie, we should take into consideration the total consumption of the installation, including the consumption of the installed hoses and applicators.

Before connecting, make sure that the voltage that is being connected to the melter is the correct one appearing on the equipment’s characteristics plate.

Connect the machine and check to see if it is well grounded.



Warning: Risk of electrocution. Even when the equipment is turned off, voltage remains in the intake terminals, which may be dangerous during internal equipment manipulations.

Install a power switch for disconnecting the melter equipment from the electrical network. It must be protected against overload and short circuits by circuit breaker and install appropriate personal protection leads to mass by differential switch.

Consumption figures, according to melter and output configuration, are included in the table in the section ‘Electrical power connection’.

Other factors

While installing these melters, other practical considerations should be kept in mind:

- Keep the load opening accessible for comfortable melter filling.
- Position the melter equipment in such a way that you can easily see the front panel display where temperatures and possible alarm signals are shown.
- As much as possible, try to avoid unnecessarily long hoses that result in elevated electrical energy consumption levels and pressure drops.
- Do not install the melter equipment beside powerful heat or cooling sources that may have distortional effects upon its operation.
- Avoid melter vibrations.
- Make sure that the melter maintenance areas (filter, purging valve, tank interior, etc.) are easily accessible.

Unpacking

Before proceeding with the installation of the melter, it should be removed from its location on a pallet and examined in order to detect any possible breakage or deterioration. Communicate any defect, even to the outer packing materials, to your Meler Representative or to the Main Office.

Contents

The equipment packing materials may contain accessories that form part of the same order. If this is not the case, the following are the standard components that accompany the melter:

- Instruction manual.
- Guarantee card.
- Connector for external I/O (included on the power card).

Mounting the equipment

For mounting the equipments set the base in the desired location using the indicated holes M8 screws. To move the equipment more comfortably use the eyebolts included for this purpose.

Warning: Make sure that the bench where the base plate is fastened is level, free from vibrations and is able to support the weight of the equipment in addition to the full tank load.



Electrical power connection

SF10 and SF20 melters are designed to be connected to the electrical power supply in two possible ways, depending on the power of different elements connected:

- 2-phases 200-240 VAC without neutral.
- 3-phases 200-240 VAC without neutral.



A good ground connection is required in all cases.

Consumption figures, according to melter and output configuration, are included in the table. For this calculation, only the case of a single pump has been taken into account. For consumption with a double pump, please check with us. Due to high power connected Meler recommends 3-phases 200-240 VAC without neutral connection.



Warning: Risk of electrical shock. Carelessness may cause injury or death.



Open the electric cabinet door as far as possible. Thread the power cord (max. Ø14.5mm) through the electrical wall bushing Pg 16 and fasten it to the inside anchor, making sure that the cord reaches the power card connector at the position where it will be installed.

Connect each wire in the power cord to its corresponding place on the power intake connector on the power card.

Consumption values concerning each equipment can be found in the characteristics plate.

Equipment	No. Outputs	2 Phase	3 Phases
		200 - 230VAC	200 - 230VAC
SF10	4	28 A	16 A
SF20	4	28 A	18 A

2-phases 200-240 VAC without neutral connection

Connect each wire in the power cord to its corresponding place on the power intake connector on the power card.



WITHOUT NEUTRAL

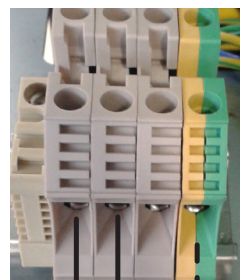

L1 L2 PE

2~230V 50/60Hz + PE

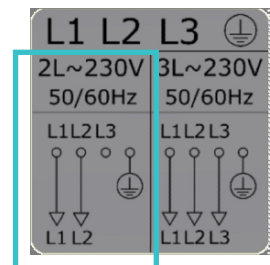

3-phases 200-240 VAC without neutral connection

For this type of connection it is necessary to replace the inner 2-phase cable with a 3-phase cable supplied with the equipment.

1. Disassemble the internal 2-phase cable, loosening the power card connector (A) and the connections on the terminal (B).
2. Connect the internal 3-phase cable, connecting it to the power card (A) and to the terminal connections (B). It is important to observe the numbering of the phases.
3. Connect each wire in the power cord to its corresponding place on the power intake connector on the power card.

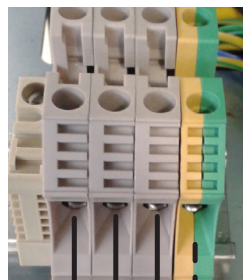

L1 L2 L3 PE
3~230V 50/60Hz + PE

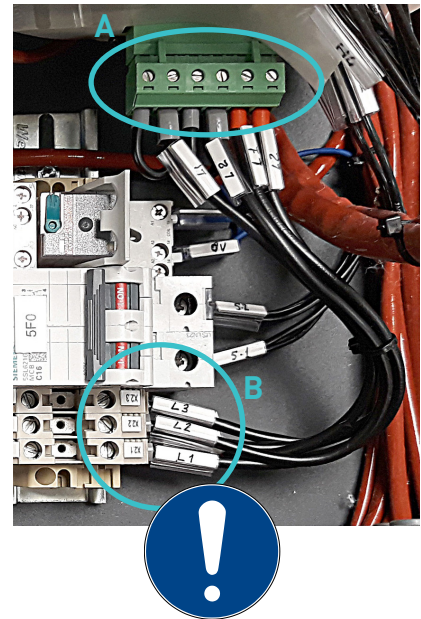
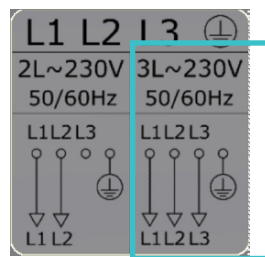

Hose and applicator connection

These series melters use standard Meler components. The entire range of Meler hoses and applicators may be connected to this equipment.

Up to four hose-applicator outputs may be connected to SF10 and SF20 melters.

SF10 and SF20 melters are equipped with a simple hydraulic distributor with four possibilities of hydraulic connection. The outputs are not numbered so the hoses can be connected to the distributor in any order.



Warning: When connecting hose-applicator outputs, verify that the connected power is not above the maximum allowable power for each output.



Caution:

- It is preferable to use couplings at 45° and 90° angle to minimize the space the hoses occupy. Using straight couplings usually results in curves with very small radii that may damage the inside of the hose.
- Save the screw-on caps that are removed from the distributor in order to connect a hose. They may be necessary in the future if a hose is removed from its location.
- Perform the electrical hose and applicator connections with the equipment turned off. Failing to do so may result in electrical defects in the connection and the appearance of alarm messages on the melter display.

Parameter Programming

Once the melter and its components are installed, you will need to program the operational parameters appropriate for the specific application that will be performed.

SF10 and SF20 simplify this task as much as possible, allowing the operator to modify only those parameters that are necessarily variable for each application.

Among the various parameters, it is necessary to program the set point temperature values for each component connected and the value for overheating warnings. There are two other parameters (weekly start-up and shut-down programming and the standby temperature value) left to program in advanced systems, although the factory default values are perfectly valid for operational purposes.

Programming working temperatures

The melters leave the factory with the following set point temperatures:

- 160 °C (320 °F) for the tank and the distributor.
- 160 °C (320 °F) for hoses and applicators.

The general process for modifying set up temperature values for any component is described below.



1. Select the component for which you wish to modify the value with the left-right arrow.

The corresponding LED will blink quickly.

2. Using the up-down arrow, select the desired value for the set point temperature.
3. After ten seconds, the LED will stop blinking and the display will change by default to the set point temperature, saving the changed data.

This simple process must be repeated for each one of the components installed on the melter.

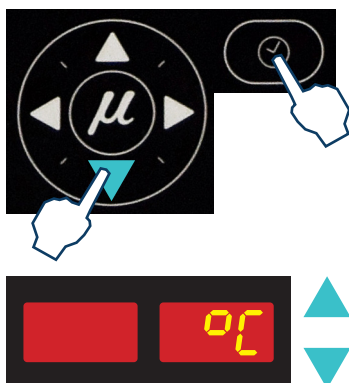

Selecting the overheating value

1. Press the buttons with the clock symbol and the down arrow at the same time to enter the special menu.

The choice of display units [°C or °F] will appear on the display.

2. Using the right arrow, we advance to the next screen where the overheating symbol appears. 
3. Select the desired value with the up-down arrow.

The value displayed corresponds to the increase in real temperature over the set point temperature permitted without activating the alarm message.

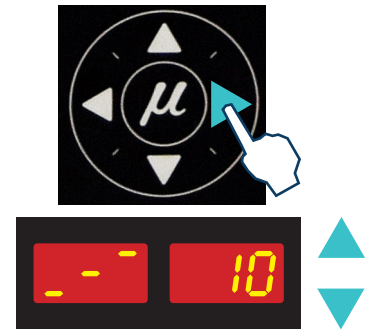

4. Use the right arrow to advance to the next screen.
5. Exit the special menu using the left arrow and the tank temperatures will once again be displayed.

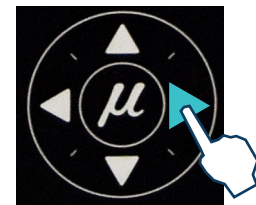

All the special menu values will be saved.

Keeping a component on display

By default, the main display shows the tank temperatures. However, it is possible to display indefinitely the temperatures of any component for analysis or tracking.

1. Select the component you wish to see permanently with the left-right arrow.

The corresponding LED will blink rapidly.

2. Hold the arrow button down for two seconds, selecting the desired component.
3. The display will now remain on the selected component, without changing.
4. Simple press any left-right arrow button again to restore the default display (tank).

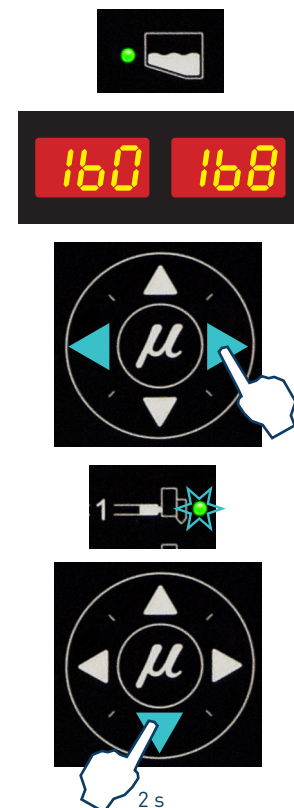

External I/O connections

The melter's input and output signals (I/O) allow it to communicate with the main machine simply and directly.

There are five signals that may be used to communicate with the main machine:



- **Temperatures ok**_an output from a contact that communicated to the main machine (or to a warning light beacon) that all the system temperatures have reached 3 °C (37,4 °F) below their set point value (and the delay time have finished) during start-up, or that their real value is not 20 °C (68 °F) below their set point value during operation.
- **External Standby**_control input from the standby mode, via a mechanical switch. The standby function is connected with a closed contact; an open contact disconnects it.
- **Low level (Optional)**_an output from a 24V / 250mA contact that communicates to the main machine (or to a warning light beacon) that the adhesive fluid level in the tank has reached the minimum level established.
- **Output disabled**_disabled input signal for each hose-applicator output via a non-voltage contact. With a closed contact, the output remains activated (output on); with an open contact, it is deactivated (output off).
- **Pumping external permission**_the motor start up may be controlled by closing an external mechanical switch.



With variable speed box installed (optional):

- **Motor start up**_the motor start up may be controlled by closing an external mechanical switch.
- **Motor speed set point**_the rotational speed of the motor (and therefore, the pump) may be controlled by means of a 0 to 10V DC external signal.
- **Failures output in pump control card**_output from a non-voltage contact that communicates normally to a warning light beacon the failure from the pump control card.



Warning: Risk of electric shock. Carelessness may cause injuries or death.



If any of these signals are to be connected, switch off and disconnect the melter and open the electrical cabinet for greater convenience while carrying out this task. To do this, open the electrical cabinet panel by loosening the four screw indicated.

Temperature ok

1. If only this signal will be connected, use a 0.5 mm² two-wire cable.
Install an electrical wall bushing Pg next to the electrical supply input.
2. Thread the electrical wire through the electrical wall bushing Pg and fasten it to the inside anchor, making sure that the cord reaches the terminal XTOK.
3. Connect the two wires from the start-up signal to the terminals XTOK1 and XTOK2. This is a double terminal, which makes it necessary to connect each wire in one of the two holes in the terminal. Since this contact is not under voltage, there is no connection polarity.
4. Make sure that the cables are firmly attached by the terminal screws.
5. Make sure that the cable is well connected and that its path through the electrical cabinet presents no risks of snagging, being cut or any other accidental deterioration.

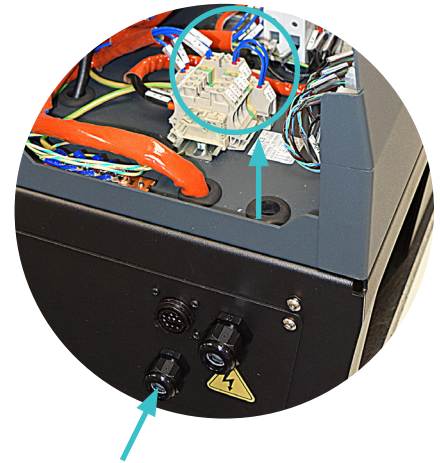

Warning: It must be connected to 24 AC or DC voltage with a maximum current of 500mA. If you connect this signal to 230V load current cannot be less than 50mA.



External standby

1. If this is the only signal being connected, use 0.5 mm² two-wire cable.
Install an electrical wall bushing Pg next to the electrical supply input.
2. Thread the electrical wire (max. Ø12.5mm) from the mechanical contact switch through the electrical wall bushing and fasten it to the inside anchor, making sure that the wire reaches the control card connector at the position where it will be installed (CN 4).
3. Remove the connector from the card and connect the two cable wires of the external mechanical switch to their corresponding connector terminals:

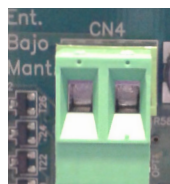

contact NO
contact NO

4. Reconnect the card connector.
5. Make sure that the cable is well connected and that its path through the electrical cabinet presents no risks of snagging, being cut or any other accidental deterioration.



Low level (optional)

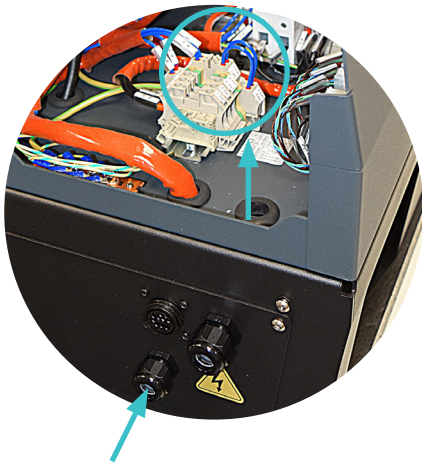

1. If only this signal will be connected, use a 0.5 mm² two-wire cable.
Install an electrical wall bushing Pg next to the electrical supply input.
2. Thread the electrical wire through the electrical wall bushing Pg and fasten it to the inside anchor, making sure that the cord reaches the terminal XLD.
3. Connect the two wires from the end-up signal to the terminals. It is possible two connectios mode:
 - XLDCM (-) and XLDNC (+) terminals. Contact indicates level NO OK.
 - XLDCM (-) and XLDNO (+) terminals. Contact indicates level OK.
- Remark:** This output contact is under 24V / 250ma.
4. Make sure that the cables are firmly attached by the terminal screws.
5. Make sure that the cable is well connected and that its path through the electrical cabinet presents no risks of snagging, being cut or any other accidental deterioration.

Output disabled



1. If this is the only signal being connected, use a seven-wire cable no smaller than 0.22 mm².
Install an electrical wall bushing Pg next to the electrical supply input.
2. Open the door to the electrical cabinet as far as possible. Thread the electrical wire (max. Ø12.5mm) through the electrical wall bushing Pg and fasten it to the inside anchor, making sure that the wire reaches the control card connector at the position where it will be installed (CN 5).
3. Remove the connector from the card and connect the two cable wires to their corresponding connector terminals:

1	common (+) voltage output
2	input for disabled output 1
3	input for disabled output 2
4	input for disabled output 3
5	input for disabled output 4
6	input for disabled output 5
7	input for disabled output 6
8	without connection
4. Reconnect the card connector.
5. Make sure that the cable is well connected and that its path through the electrical cabinet presents no risks of snagging, being cut or any other accidental deterioration.

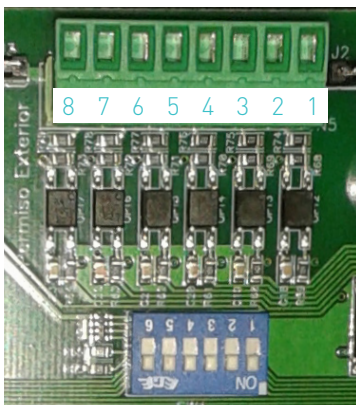

It is possible to select the channels that you want to control from the outside using the small switches located above the connector. Switches 1 through 6 control each of the channels, so that the switch in the 'ON' position means heating from the equipment, without any external control.

When the switch is in the 'OFF' position, the corresponding channel does not heat unless activated from the outside, through a non-voltage contact between pin 1 (the common pin) and the pin that corresponds to the channel.

Pumping external permission

1. If only this signal will be connected, use a 0.5 mm² two-wire cable.
Install an electrical wall bushing Pg next to the electrical supply input.
2. Thread the electrical wire through the electrical wall bushing Pg and fasten it to the inside anchor, making sure that the cord reaches the terminal XP.
3. Remove the jumper and connect the two wires from the mechanical contact switch to the terminals XP1 and XP2.
4. Make sure that the cables are firmly attached by the terminal screws.
5. Make sure that the cable is well connected and that its path through the electrical cabinet presents no risks of snagging, being cut or any other accidental deterioration.

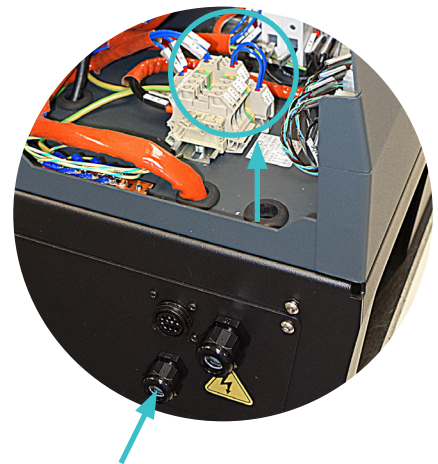

Variable speed box optional intallation

SF10 and SF20 melters are prepared by default for being upgraded with an external electrical board for converting it into a variable speed melter.

1. Connect the box wire in the connector on the rear side of the melter.
2. Open the melter electrical cover and remove the jumper in 6X3 terminals.

To configure and operate the variable speed box system see the chapter '4. Melter operation' in this manual.



Starting up the motor (ok ext)

1. If this is the only signal being connected, use 0.5 mm² two-wire cable.
Install an electrical wall bushing Pg next to the electrical supply input.
2. Thread the wire cable (max. Ø12.5mm) through the electrical wall bushing and fasten it to the inside anchor, making sure that the cord reaches the card connector.
3. Connect the two wires from the external mechanical contact switch t to the terminals E3.
4. Make sure that the cables are firmly attached by the terminal connector.
5. For the signal to work, the led 'ok ext' on the control panel must be on.

Motor speed set point reference (ref ext)

1. If this is the only signal being connected, use 0.5 mm² two-wire cable.
Install an electrical wall bushing Pg next to the electrical supply input.
2. Thread the wire cable (max. Ø12.5mm) through the electrical wall bushing and fasten it to the inside anchor, making sure that the cord reaches the card connector.
3. Connect the two wires from the start-up 0-10V DC signal to the terminals E2. This is a double terminal, which makes it necessary to connect each wire in one of the two holes in the terminal. The positive signal wire must be connected to point E2+ of the terminal, while the negative wire must be connected to point E2-.
4. Make sure that the cables are firmly attached by the terminal connector.
5. For the signal to work, the led 'ref ext' on the control panel must be on.

Failures output in pump control card

1. If this is the only signal being connected, use 0.5 mm² two-wire cable.
Install an electrical wall bushing Pg next to the electrical supply input.
2. Thread the wire cable (max. Ø12.5mm) through the electrical wall bushing and fasten it to the inside anchor, making sure that the cord reaches the card connector.
3. Connect the two wires from the end-up signal to the terminals S4. This is a double terminal, which makes it necessary to connect each wire in one of the two holes in the terminal. Since this contact is not under voltage, there is no connection polarity.
4. Make sure that the cables are firmly attached by the terminal screws.

Warning: It must be connected to 24 AC or DC voltage with a maximum current of 1A.



LAY OUT PUMP CONTROL BOARD

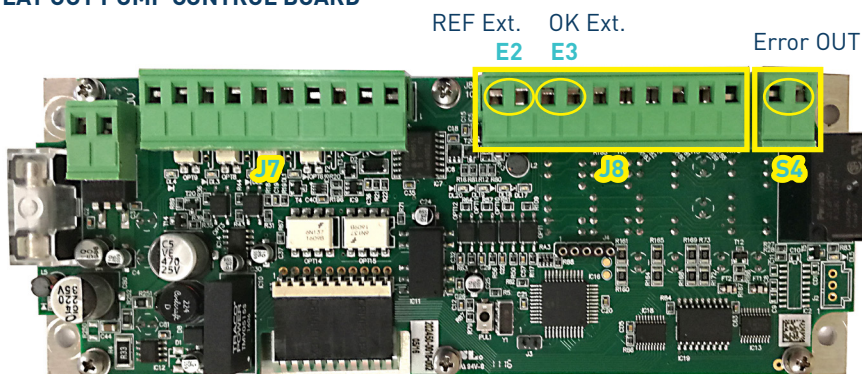

This page is intentionally left blank.

4. MELTER OPERATION

In this section we will introduce the method for using the melter. Although its operation is very simple, it should not be used by untrained personnel.

Warning: Improper use may cause damage to the machine or injury and even death to the person using it.



General information

There are three large groups of components with thermal control in a hot-melt installation: the fusion unit, the transport hoses and the applicators. All of these are controlled from the front panel of the melter.

The first large group is the tank-distributor group. Combined to form a single unit, they have separate controls even though their set point values are the same. Therefore, when you program a set point value for the tank, for example 170°C (338 °F), the distributor adopts this same value. If two pumps are installed, the distributors occupy channels 1 and 2 with set point values and control that are independent to the tank and to each other.

The second group is the hose group. They are identified on the front panel, depending on the equipment model, by number, from No.1 to No.4 and by the corresponding hose picture. Each one has its own set point value.

The third group is the applicator group. It is identified on the front panel, depending on the equipment model, by number from No.1 to No.4 and by the corresponding applicator picture. Each one has its own set point value.

The hose and applicator numbers are automatically assigned to the hose/ applicator channel they are connected to on the rear part of the melter.

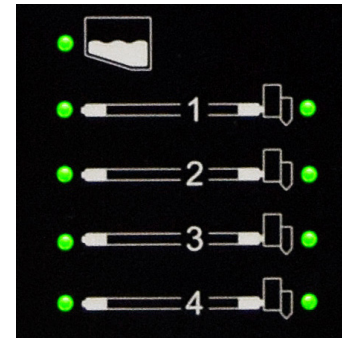

Filling the tank

The tank may be equipped optionally with one capacitive detector. The capacitive detector issues a warning when the adhesive reaches the level, thanks to a low adhesive level external signal.



Warning: Before refilling the tank, make sure that the adhesive is the same type as that already in the tank. Mixing different types of adhesives can cause damage to the melter equipment.

Warning: Risk of burns. Always refill using protective gloves and goggles.

To fill the tank:

1. Open the tank lid.
2. Use a shovel or a ladle to fill the tank with adhesive. Do not fill the tank above the loading opening level. The lid must be able to close normally.
3. Close the lid when you have finished refilling the tank.

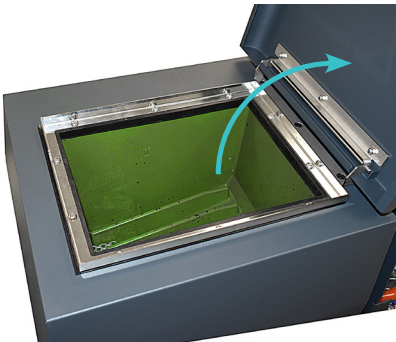

Model	Capacity	
SF10	10 l / 2.64 gal	10 kg / 22 lb
SF20	20 l / 5.28 gal	20 kg / 44 lb

* for density of 1 g/cm³

Starting up the melter equipment

Before starting up the melter equipment, it is necessary to check to see if the unit has been correctly installed and all its input/output and accessory connections are correctly established.

It is also necessary to make sure that the equipment has been filled with adhesive and that the operational parameters have been programmed.

To start:

1. Connect the melter's switch.

If the control card was turned off the last time the machine was disconnected, it will remain tuned off when the machine is started up again (time display).

If the control card was on the last time that the machine was disconnected, it will turn on when the machine is started up again.

2. Press the ON/OFF button on the control card to turn it on, if it not already activated.

By default, the set point and real temperature values shown are those corresponding to the tank.

The tank heating control LED (green) will light up and the tank will begin to heat.

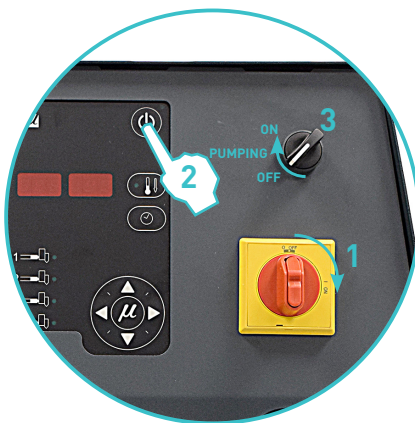

Once it has reached 3 °C (37.4 °F) below the programmed temperature (set point) of the tank, a programmable delay timer starts until, guaranteeing fusion, the pump receives permission to operate and the signal will be sent to the main machine, indicated by the two corresponding (green) LEDs.

While the system is running the delay timer both LEDs remain blinking until the programmed time value has been reached. If then, any other element has not reached 3 °C (37.4 °F) below its temperature setting point, the LEDs turn off.

If the system is shut down, for any possible mode, when it is turning on the delay timer only starts again if the tank temperature is 20 °C (68 °F) below setting point.

3. To start pump, put the pump switch in the position Pumping ON.
4. In case of you install a variable speed box (optional), make sure that the pumping control card is ON and the selectors in the pumping control card is in the correct position (see Chapter '2. Introduction. Operating modes').

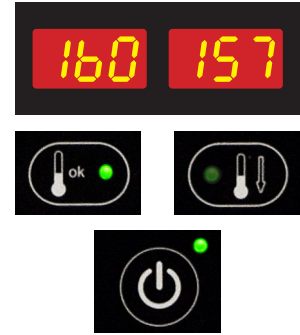

Melter equipment displays

SF series melters have two displays built into their control panel, with three sets of 7 segments each for displaying the temperature values (set point and real temperature), programmable parameters and alarms.

They are equipped with LED indicators to display the heating of each component, as well as the pump activations and the main machine connection

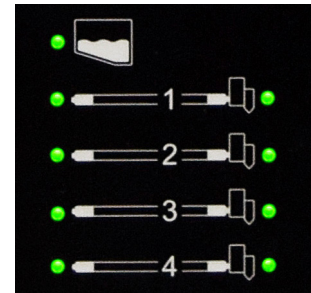

LED display	Component heating	Component status
constantly lit	constant	low temperature
blinking slowly	as need (according to PID parameters)	temperature near set point
blinking rapidly	programming or display	change in set point values
off	not heating	temperature reached

signal:

They are also equipped with LEDs indicating equipment connection/disconnection and standby function connection/disconnection:

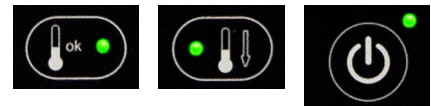

LED display	On/off	Standby
constantly lit	turned off unit	function activated
blinking slowly	deactivation programmed for the current day	activation programmed for the current day
blinking rapidly	activation/deactivation programming mode	activation/deactivation programming mode
off	unit in operation	function deactivated
simultaneous intermittence from leds of pump activation and main machine signal	timing in progress, once the tank has reached its set point temperature	

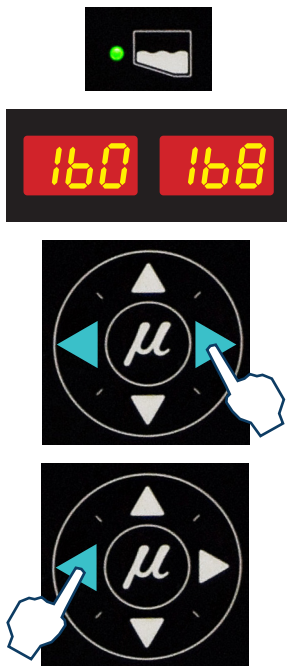

Displaying the temperature for each component

The temperature may be displayed for each component (tank, distributor and each hose and applicator) by selecting the component with the cursor.

Press the left-right arrow until the desired component is displayed.

After 10 seconds, the display will return to the default component (the tank).

If you wish to keep the component displayed permanently, press and hold the left-right arrow for 2 seconds while selecting the chosen element.

The following is the display sequence:

distributor←—tank←—hose1←—applicator1←—j...←—hose4←—applicator4

distributor→—tank→—hose1→—applicator1→—...→—hose4→—applicator4

To remove a component from permanent display, simply press either of the left-right arrows.

Alarm displays

The melter equipments tell the user when a malfunction has occurred in the unit, sending warning messages that may be seen on the control panel display.

When an alarm appears, the control unit takes a series of steps to protect the unit. Simply correct that malfunction and the control unit will reactivate the equipment functions.

Code	Source	Actions		
		Heating	Pump	Main machine signal
Err 0	tank broken sensor	only tank off	off	off
Err 1	hose1 broken sensor	only hose1 off	off	off
Err 2	applicator1 broken sensor	only applicator1 off	off	off
Err 3	hose2 broken sensor	only hose2 off	off	off
Err 4	applicator2 broken sensor	only applicator2 off	off	off
Err 5	hose3 broken sensor	only hose3 off	off	off
Err 6	applicator3 broken sensor	only applicator3 off	off	off
Err 7	hose4 broken sensor	only hose4 off	off	off
Err 8	applicator4 broken sensor	only applicator4 off	off	off
Err 13	distributor broken sensor	only distributor off	off	off
Err 100	tank overheating	all components off	off	off
Err 101	hose1 overheating	all components off	off	off
Err 102	applicator1 overheating	all components off	off	off
Err 103	hose2 overheating	all components off	off	off

Code	Source	Actions		
		Heating	Pump	Main machine signal
Err 104	applicator2 overheating	all components off	off	off
Err 105	hose3 overheating	all components off	off	off
Err 106	applicator3 overheating	all components off	off	off
Err 107	hose4 overheating	all components off	off	off
Err 108	applicator4 overheating	all components off	off	off
Err 113	distributor overheating	all components off	off	off

Standby function does not generate any alarm.

If a temperature sensor is broken, the system heats all the elements except the one where the failure is located.

In case of overheating the system cuts off immediately the damaged element. After three minutes if the failure continues all the system will be shut down. After repairing the failure the system starts heating normally.

Display and adjustment of the working speed

The pump rotation speed (in revolutions per minute) is shown on the display for each pump control card on the equipment. These revolutions may be adjusted by using the up/down arrow keys (pumping speed, internal reference), through a voltage signal from the main machine or by modifying the full scale (pumping speed, external reference). The pump rotation speed must be adjusted to the requirements of the application.

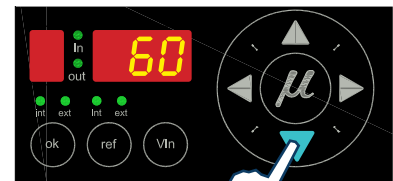

Warning: Although rotation speeds can be selected between 0 and 100 rpm it is not advisable to operate at speeds of less than 10 rpm (the flow may become inconstant depending on the motor load) or greater than 80 rpm (pump operating at maximum revolutions).

Note: for further information on adjusting working speeds, see the section 'Modes of operation'.



Temperature adjustment

The melters leave the factory with the following set point temperature values:

- 160 °C (320 °F) for the tank and distributor
- 160 °C (320 °F) for the hoses and applicators
- °F displayed
- Overheating value: 20°C (68 °F)
- Standby value: 40%
- Delay time: 10 min
- On/off and stanby programming: ON
- Low level detector: ON

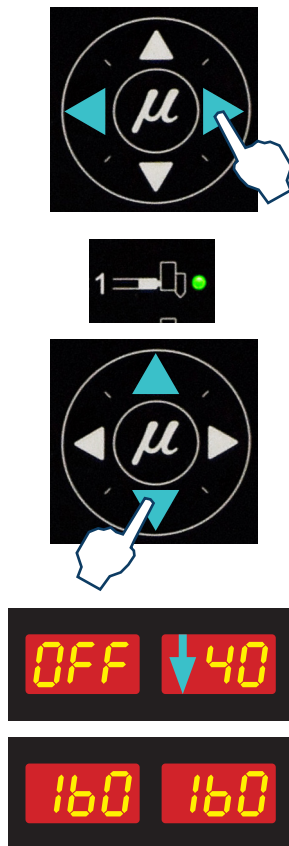

The general process for adjusting the temperatures of each components is described below.

1. Select the component whose value you wish to modify using the left-right arrow. The tank and the distributor have the same set point value.

The corresponding LED will blink rapidly.

2. Select the desired set point temperature value with the up-down arrow. Below 40°C the set point value displays 'OFF' canceling the heating of that element.
3. After ten seconds, the LED will stop blinking and the display will show the tank's set point temperature value by default, saving the modified data.

This simple procedure should be repeated for each of the components whose set point temperature value you wish to modify.

Programming the applicator parameters

The access to the parameters is performed from the special menu. Simultaneously press the buttons with the clock symbol and the down arrow to enter this menu. The navigation order is as follows:

Function	Symbol on the display	Default value
Selects the temperature unit to display	°C - °F	°F
Programs overheating	— — —	68 °F
Programs the temperature for the STANDBY mode	— — —	40%
Delay time to activate the Pump	F	10 minutes
Activates and deactivates the low tank level alarm	n	OFF
Programs the time span between the ON mode and the STANDBY mode	S-1	OFF
Programs the time span between the STANDBY mode and the OFF mode	S-2	OFF
Programs the Password for parameter protection	PAS	000
Displays the total hours of service	t	00000
Programs the partial filter change counter	tP	1000

To select the function to be programmed, press the right arrow to advance through the various functions. Once selected, the buttons up and down modify the value. Pressing the arrow right again the data is stored and passed to the next function.

To exit the special menu press the left arrow at any time.

Programming process

1. Simultaneously press the buttons with the clock symbol and the down arrow to enter the special menu.

The choice of temperature display units (°C or °F) will appear on the display.

2. Select the desired value using the up-down arrow.

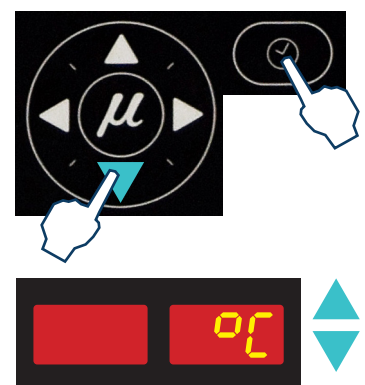
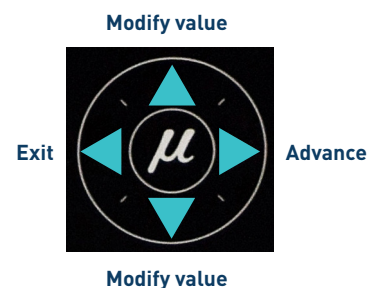

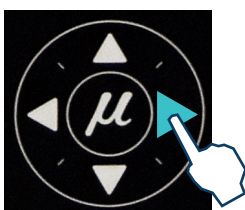
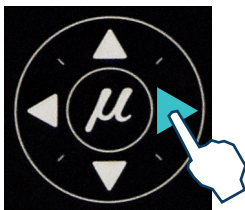
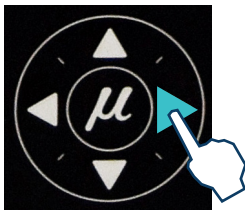
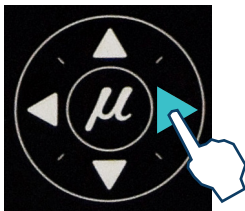
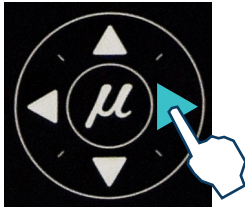

3. Use the right arrow to move to the next display where the overheating symbol appears. **---**
4. Select the desired value (between 10 and 25 °C / 50 and 77 °F) using the up-down arrow.
The value shown corresponds to the increase in real temperature allowed over the set point temperature without activating the alarm message.
5. Use the right arrow to go to the next display where the standby function symbol appears. **---**
6. Use the up-down arrow to select the desired value (between 25 and 55%).
The value shown corresponds to the percent decrease in the real temperature compared to the set point temperature that will occur when this function is activated.
7. Use the right arrow to go to the next display where delay time value appears.
8. Use the up-down arrow to select the desired value (between 0 and 60 min).
9. Use the right arrow to advance to the next screen, where the level detector activation/deactivation is found.
10. Use the up-down arrow to select the desired value (ON/OFF). When OFF is selected, neither the on-screen display nor the external signal activation will be operational. If ON is selected, when the level of hot-melt is low the alarm (n - - -) will be displayed on the screen and the external signal contact will be activated.
11. Use the right arrow to go to the next display.

12. Use the up-down arrow to select the desired value (see 'Timer to switch between ON - Standby - OFF modes').



13. Use the right arrow to go to the next display.

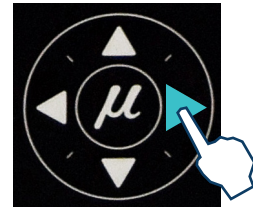

14. Use the up-down arrow to select the desired value (see 'Timer to switch between ON - Standby - OFF modes').



13. Use the right arrow to go to the next display.

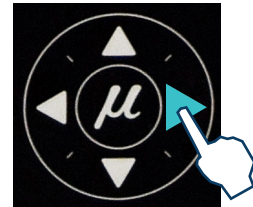

16. Use the up-down arrow to select the desired value (see 'Password to access parameter programming').



17. Use the right arrow to go to the next display.

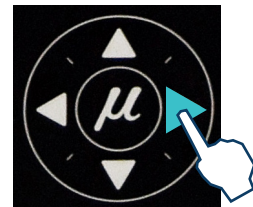

This function is a counter that registers total hours of equipment operation, that is, with service temperature OK enabled.

This is an increment counter and its value cannot be modified.

The maximum number of hours is t99999, after which the counter will return to t00000 to continue counting.



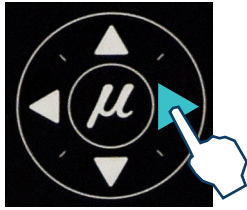

18. Use the right arrow to go to the next display.



19. Use the up-down arrow to select the desired value (see 'Counter that warns of the need to change the adhesive agent filter').

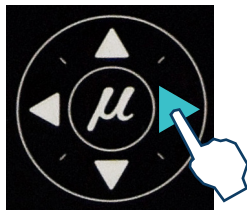

20. Use the right arrow to return to the initial parameter.



For any parameter, the left arrow may be used to exit the special menu and display the tank temperatures once again.

To record any parameter, you must always move to the next parameter, using the right arrow.

Timer to switch between ON - Standby - OFF modes

This function is used to program automatic switching from the ON mode to Standby mode after an inactive period of time (S-1) and from STANDBY mode to OFF mode after another waiting period (S-2) during which activity has not been resumed.

To program this function and ensure that it works properly, the melter must be connected to the main unit via the CN4 external standby connector on the control board. The main unit will use this connection to send continuous signals (not less than 500 ms) indicating that production is in progress. After the first programmed time elapses without any activity (S-1) the equipment will switch to STANDBY mode. If the equipment remains in standby and the 'Standby' push button is not pressed during the second programmed time (S-2), the equipment will switch to OFF mode.

To set the equipment to the ON mode again, press the 'ON/OFF' push button on the control board. The programmed S-1 time will begin a countdown the moment the melter reaches the service temperature.

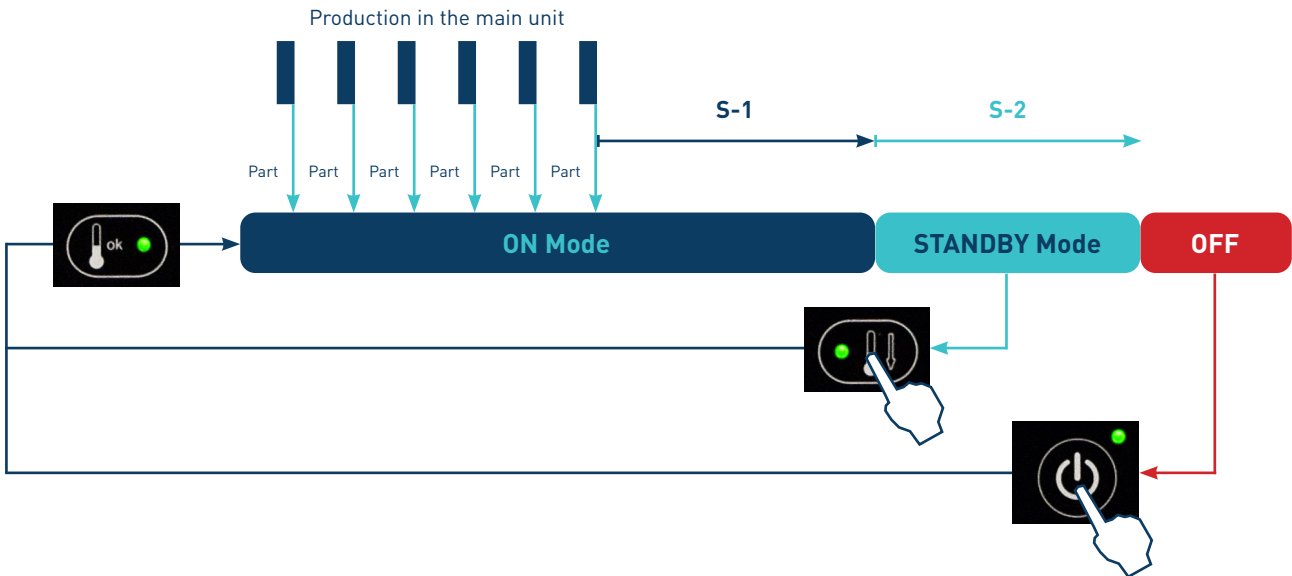

S-1	S-2	Functionality
dIS	dIS	The external Standby input (CN4) is disabled. The melter can be set to Standby mode with the push button.
OFF	OFF	The external Standby input (CN4) runs normally. <ul style="list-style-type: none"> • Contact CLOSED: Equipment in STANDBY Mode. • Contact OPEN: Equipment in ON Mode.
Between 001 and 999 (minutes)	OFF or 000	The external Standby input (CN4) detects inactivity. If no activity is taking place, once the time programmed in S-1 elapses, the melter switches from ON mode to OFF mode. It will not switch to STANDBY mode because S-2 is OFF or 000.
Between 001 and 999 (minutes)	Between 001 and 999 (minutes)	The Standby input (CN4) detects inactivity. If no activity is taking place, once the time programmed in S-1 elapses, the melter switches from ON Mode to STANDBY Mode. If no activity is taking place, once the time programmed in S-2, elapses the melter switches from STANDBY Mode to OFF Mode.

Password to access parameter programming

A Password can be programmed to protect access to certain equipment programming functions by unauthorised users.

The special menu can be used to program a value between 000 (disabled) and 999. When the Password value is a value other than 000, the equipment is protected and functions are programmed as follows:

- NO password.
 - Operation with the 'ON/OFF' and 'Standby' keys.
 - Viewing the real working temperatures.
- WITH password.
 - Modify the temperature set points.
 - Program equipment time periods.
 - Set melter parameters.

When the Password is activated in the equipment and the user attempts to access the protected functions of the equipment, the displays will show 'PAS 000'.

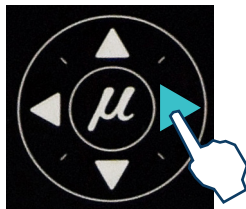

Enter the Password using the 'up' and 'down' keys.

Once the Password is displayed, press the 'right' key.

By pressing the 'left' key, the equipment will return to the same mode of operation that was active before the enter password message appeared.

If the Password is incorrect, the equipment will not access the desired menu and it will return to the same mode of operation that was active before the 'PAS 000' message appeared. No message will be displayed indicating that the Password that is entered is incorrect.

If this is correct, the equipment will access the desired menu and it will be possible to program or view the parameters.

Total equipment service hours counter

This function is a counter that registers total hours of equipment operation, that is, with service temperature OK enabled.

This is an increment counter and its value cannot be modified.

The maximum number of hours is t99999, after which the counter will return to t00000 to continue counting.



Counter that warns of the need to change the adhesive agent filter

This function is a partial countdown counter that registers the hours of equipment operation, that is, with service temperature OK activated, from tP1000 hours to tP0000 hours.

When this value is reached, the display shows the 'FIL tEr' message, which warns that the adhesive filter of the equipment must be cleaned and/or replaced.

Press any key to delete the message and the counter will return again to 1000 hours. The equipment will return to the same mode of operation that was activated before the message appeared.



Use the 'up' and 'down' keys of this function to modify this value so the filter cleaning warning adjusts to the specific needs required for melter operation.

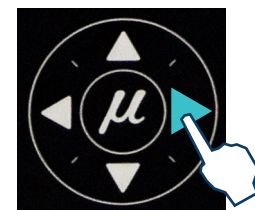

Once the value has been selected, press the 'right' key to store the new value and the 'FIL tEr' warning will be activated after the new programmed time elapses.

Setting the clock

'SF' series melters are equipped with a weekly programmable system controlling equipment connection and disconnection and activating and deactivating the standby function.

Before programming these functions, it is necessary to introduce into the control unit data corresponding to the day and hour used to execute these programs.

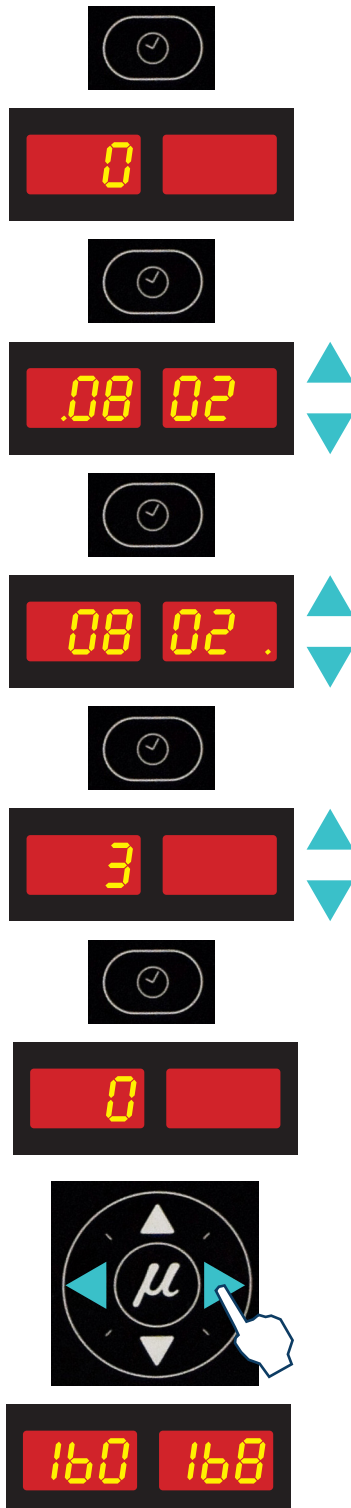

Programming the current day and hour

1. Press the button with the clock symbol.
A '0' will appear on the display, indicating the program for current day and hour information.
2. Press the button with the clock symbol once again.

On the left display, you will see the time with a dot, indicating that this is the value that may be modified, while the minutes appear on the second display.

3. Use the up-down arrow to select the desired value.
4. Press the button with the clock symbol once again.
Now the dot will appear on the right display.
5. Use the up-down arrow to select the desired value.
6. Press the button with the clock symbol once again.

A number appears, indicating the day of the week (1- Monday / 7- Sunday).

7. Use the up-down arrow to select the desired value.
8. Press the button with the clock symbol once again.

The '0' program appears once again.

9. Pressing either the left or the right arrow button will exit this program and return to the tank temperature display.

Programming equipment activation/deactivation

You may program an activation and a deactivation time for every day of the week, from Monday (1) to Sunday (7).

Time is expressed in 15 minute increments, so we cycle from 10.0 (10 hours and 0 minutes) to 10.1 (10 hours and 15 minutes) to 10.2 (10 hours and 30 minutes) to 10.3 (10 hours and 45 minutes).

1. Press the button with the clock symbol

A '0' will appear on the display, indicating the program for current day and hour information.

2. Use the up-down arrow to select the value for the desired day of the week, from Monday (1) to Sunday (7).

3. Press the button with the clock symbol once again.

Two times will appear, one in each display. The display on the left shows the start time, while the display on the right shows the finish time.

4. The blinking dot next to the start time indicates that this is the value that may be modified. Use the up-down arrow to select the desired value.

5. Press the button with the clock symbol once again.

The dot changes to the finish time.

6. Use the up-down arrow to select the desired value.

7. Press the button with the clock symbol once again.

The selected program will appear once again. Use the up-down arrow to select other programs.

8. Pressing either the left or the right arrow button will exit this program and return to the tank temperature display.

The green LED next to the 'ON/OFF' button will remain blinking as long as there is an equipment disconnection time programmed for the current day.



Disabling the equipment activation/deactivation program

It is possible to disable the equipment activation/deactivation programming without canceling the daily programming. This way the programmed data is saved, but the programming will have no effect on the equipment.



1. Press the button with the clock symbol.

A '0' will appear on the display, indicating the program for current day and hour information.

2. Use the up-down arrow to go past the selection for the last day of the week (7).

The message 'ON/OFF' will appear on the display, depending on the current status.

3. Press the button with the clock symbol once again.

The status will alternate each time you press the button.

4. Pressing either the left or the right arrow button will exit this program and return to the tank temperature display.

Programming the equipment's standby function activation/deactivation

You may program an activation and a deactivation time for every day of the week, from Monday (1) to Sunday (7).

Time is expressed in 15 minute increments, so we cycle from 10.0 (10 hours and 0 minutes) to 10.1 (10 hours and 15 minutes) to 10.2 (10 hours and 30 minutes) to 10.3 (10 hours and 45 minutes).

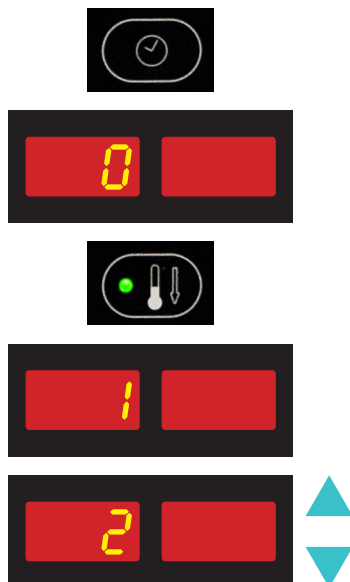

1. Press the button with the clock symbol.

A '0' will appear on the display, indicating the program for current day and hour information.

2. Press the standby function button.

A '1' will appear, indicating the first day in the standby function programming.

[Since the current time and date are values common to both programs, the value '0' does not appear in this menu].

3. Use the up-down arrow to select the desired value for the day of the week, Monday (1) to Sunday (7).

4. Press the button with the clock symbol once again.

Two times will appear, one in each display. The left display shows the start time, while the right display shows the finish time.

- The blinking dot next to the start time indicates that this is the time that may be modified.

Use the up-down arrow to select the desired value.

- Press the button with the clock symbol once again.

The dot changes to the finish time.

- Use the up-down arrow to select the desired value.

- Press the button with the clock symbol once again.

The selected program appears once again. You may use the up-down arrow to select other programs.

- Pressing either the left or the right arrow button will exit this program and return to the tank temperature display.

The green LED next to the 'maintenance' button will remain blinking as long as there is an equipment standby function activation time programmed for the current day.

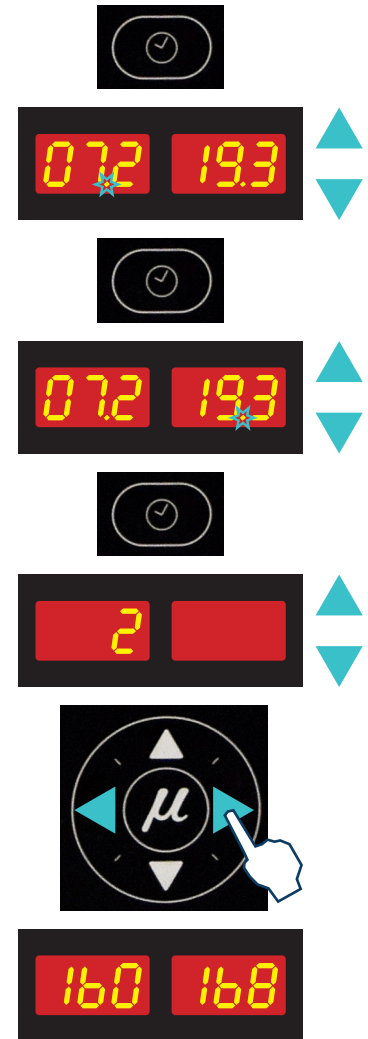

Disabling the equipment standby function programming

It is possible to disable the equipment standby function programming without canceling the daily programming. This way the programmed data is saved, but the programming will have no effect on the equipment.

- Press the button with the clock symbol.

A '0' will appear on the display, indicating the program for current day and hour information.

- Press the standby function button.

A '1' will appear, indicating the first day in the standby function programming.

- Use the up-down arrow to go past the selection for the last day of the week (7).

The message 'ON/OFF' will appear on the display, depending on the current status.

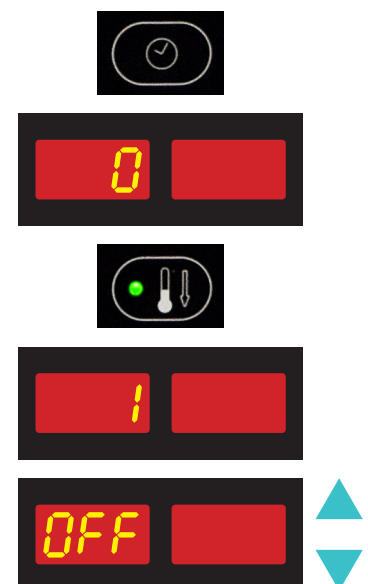

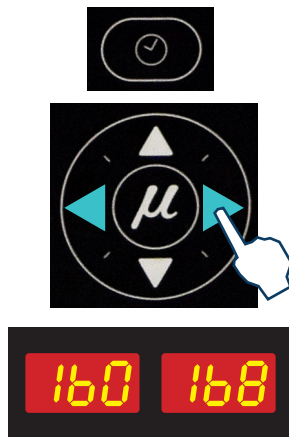

4. Press the button with the clock symbol once again.
The status will alternate each time you press the button.
5. Pressing either the left or the right arrow button will exit this program and return to the tank temperature display.

Special function buttons

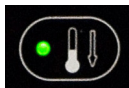

The simplicity of programming 'SF' series melters/applicators reduces the use of the special function buttons to only the standby function.

This manual function allows you to alternate between the operational mode and the standby mode. Using the standby function during periods of melter/applicator inactivity helps save energy and allows the heated elements to return quickly to their set point temperatures once you return to the operational mode.

When the standby function is activated, the set point temperature for all the heated components is lowered to a certain value, according to the programmed parameter (see 'Programming melter/applicator equipment parameters'). For example, if the tank set point temperature is 160 °C and the standby temperature is programmed as 30 (30%), when you press the standby function button, the tank set point temperature will drop to 112 °C (70% of 160 °C).

The three means for activating the standby function available with 'SF' melters/applicators have the following priority protocols:

- 1° manual standby function button
- 2° standby function external signal
- 3° standby function activation/deactivation programming

Therefore, if the function is activated by any of the three means, it may always be deactivated using the manual button. On the other hand, if it was activated using the manual button, it may not be deactivated by either of the other two means. The weekly programming may not deactivate a standby function that has been activated by either of other two means.

The following criteria are suggested for standby function use:

- If the period of inactivity is less than 2 hours, allow the melter applicator equipment to heat as normal.
- If the period of inactivity is more than 2 hours and less than 4 hours, use the standby function.
- If the period of inactivity is over 4 hours, use one of the following two options: turn off the equipment if you do not plan on using it for the rest of the day or keep the standby function on if you plan on using the equipment during that same day.

Pumping control (Optional)

Starting up the pump control card

The pump control card (hereinafter also control card), features an ON-OFF button that allows us to turn off the displays and LEDs (leaving on only the 24 Vdc power supply LED)

The control card will turn off automatically depending on the status of pumping permission input:

- Whenever the pumping permission input is deactivated, the interface will be turned off and the control will be inoperative, unless turned on with the control card ON-OFF button.
- Should the 24 Vdc power supply to the control card be lost, on recovering the power supply the control card will remain turned off until pumping permission input is activated. If on recovering the power supply the pumping permission input is activated, it will turn on directly.
- If the power supply is available and pumping permission has not been received and the control card be turned off it must be turned on with the control card ON-OFF button.

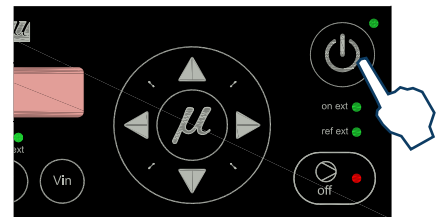
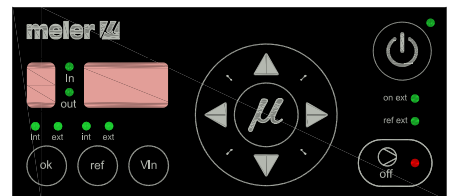
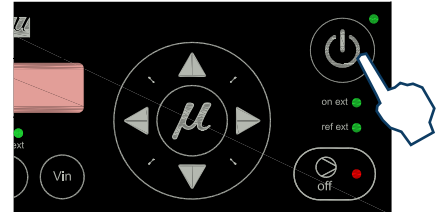

Pumping safety measures

To prevent the equipment from starting up unexpectedly, the control panel features by default a safety option that prevents pumping from commencing until enabled by pressing the ON-OFF button on the control card. This function may be disabled in the 'User configuration menu'.

For the pumping control to allow the pump to operate, the pumping ON-OFF button must be pressed, leaving it enabled (the red LED on the pumping ON-OFF button will turn off). When enabled, the control card will allow pumping as soon as all the required conditions are recovered, including pumping permission.

When pumping safety is enabled:

- In the event of loss of 24 Vdc power supply or the control panel is turned off with the control card ON-OFF button, the control will start up with pumping disabled (red ON-OFF button LED is illuminated) on recovering the power supply or turning the control card on, and prevent pump operation even if the pumping permission input is closed again, until the pumping ON-OFF button is pressed and the red LED turns off.
- Whenever the pumping permission input is deactivated, the control disables pumping (red ON-OFF button LED is illuminated) and prevents the operation of the pump even if the pumping permission input is closed again, until the pumping ON-OFF button is pressed and the red LED turns off.

- Whenever an error occurs, the control disables pumping (red ON-OFF button LED is illuminated) and prevents the operation of the pump until the error is reset, the pumping ON-OFF button is pressed again and the red LED turns off.

When pumping safety is disabled:

- In the event of loss of 24 Vdc power supply or the control is turned off with the control card ON-OFF button, on recovering the power supply or turning on the control card the control maintains the enabled status of the pumping ON-OFF button (if this was at the position ON, the unit will start up in ON and if it was at the position OFF it will start up in OFF).
- Whenever pumping permission input is deactivated, the pumping control stops the pumping operation, but does not disable it (red ON-OFF button LED turned off) and will allow pumping operation as soon as the pumping permission input is closed again.
- Whenever an error occurs, the pumping control stops the pumping operation, but does not disable it (red ON-OFF button LED turned off) and will allow pumping operation.

To deactivate pump safety see the section 'User configuration menu', paragraph 5.

Password security

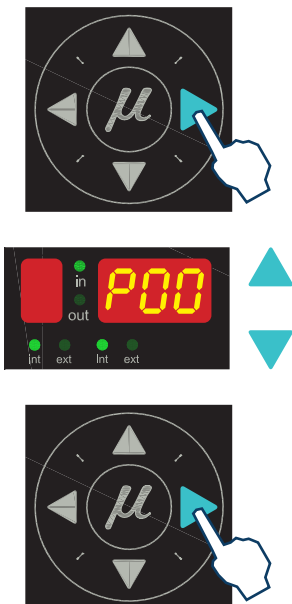

If the option selected in the password security configuration is '1', security enabled, only the control card ON/OFF and pumping ON/OFF buttons will be operational. While this security option is programmed, in order to avoid the need to turn off and restart the machine to return to the 'User configuration menu', on pressing any key (except the control card ON/OFF and pumping ON/OFF buttons) a password will be required. When the password is entered correctly, the control card can be left operational by setting it to '0'. When using this method to access the control card security configuration options, i.e., when the password has been entered, the buttons on the control card are temporarily unprotected until one minute has elapsed during which no buttons are pressed or until any key is pressed and the control panel resumes its protected status.

Whenever you are requested to enter a security password, the message P00 will appear on the displays. With the up/down arrow keys, select the 3-digit number that is your security password; as soon as the correct value for the programmed password is selected, press the right arrow key, if the password is correct, it will allow access to the selected field. The right arrow key will validate the password, provided it is the correct one; if it not the correct one, the message P00 will reappear on the screen and the process will recommence.

By default, the password is set to '000'.

LED indicators

Described below are the LED indicators on the pump control card to identify the status of the equipment:

- 1. Control card ON/OFF LED:** when the external 24 Vdc power supply is present, this LED will always be illuminated; with no power supply, it will be turned off. This LED is green in colour.
- 2. Pumping ON/OFF LED:** when pumping is enabled, this LED will be turned off, and will be illuminated when pumping is disabled. This LED is in colour.
- 3. Int and ext (ok) LEDs:** when the equipment is operating in Internal start-stop (ok) mode, the 'int' LED will be illuminated and the 'ext' LED will be turned off. When the equipment is operating in external start-stop (ok) mode, the 'ext' LED will be illuminated. And the 'int' LED will be turned off. These can never be both on or both off at the same time. These LEDs are green in colour.
- 4. Int and ext (ref) LEDs:** when the equipment is operating in internal reference mode, the 'int' LED will be illuminated and the 'ext' LED turned off. When the equipment is operating in external reference mode, the 'ext' LED will be illuminated and the 'int' LED will be turned off. These can never be both on or both off at the same time. These LEDs are green in colour.
- 5. Ext on LED:** when the equipment is operating in external start-stop (OK) mode, and the external permission contact is closed, this LED will be illuminated; if the external contact is open, this LED is turned off. This LED is green in colour.
- 6. Ext ref LED:** when operating in external reference mode and the external reference voltage is other than zero, this LED will be illuminated. When the external reference voltage is zero, this LED will be turned off. This LED is green in colour.
- 7. In/Out LED:** when operating in external set point reference mode, these LEDs will be activated and deactivated as the speed ramp options are programmed. These LEDs are green in colour.

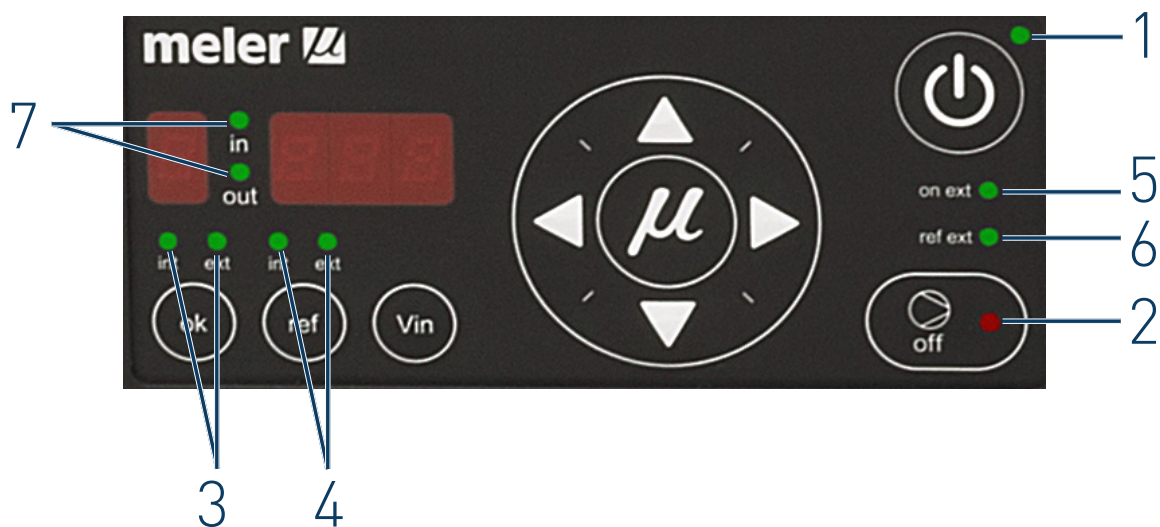

Modes of operation

First of all, we must bear in mind that when password security is enabled and the control card is not manipulated during one minute, it is blocked and you need to enter the password. To prevent this from happening, password security may be disabled following the steps in the section 'Password security'.

Mode of operation with internal pumping control and internal speed control

In this working mode the user has full control of the start/stop function and speed pump set.

Follow the steps below to use this operating mode:

1. Press the ON/OFF button to light up the control card.
2. Select 'ok' in the position 'int' and 'ref' in the position 'int'.

To activate the start-up status, all of the following conditions must be met:

- That the input for pumping permission (E4) at central control is activated, as pumping is not possible unless the equipment temperature is OK.
- That pumping is enabled with the pumping ON-OFF button (red LED is turned off).
- That the failure input is not activated (E5), in which case starting the pump would be impossible. In case of the pump be operating and this input is activated, pumping will cease immediately.

If a speed has been previously set, this value will be shown on the display and the pump will start to rotate at the speed indicated provided that all prior conditions are met. Otherwise:

3. Using the up/down arrows, select the rotation speed and/or wait for pumping permission to be enabled (red LED is turned off).

At this moment, the pump will start to rotate at the speed indicated on the display.

4. Adjust the rotation speed to the value required for the application. The selected value is set pressing the right arrow key after blinking three times.

The pump will stop whenever:

- The control card is disabled with its ON/OFF button.
- The pumping ON-OFF button is pressed (red LED is illuminated).
- When a variator error signal is activated (E5).
- When the MAXIMUM RPM ALARM TIME appears.
- When the MINIMUM RPM ALARM TIME appears.

The maximum full scale for admissible revolutions is 100 (we recommend working at speeds of not less than 10 rpm and not greater than 80 rpm).

This full scale can be adjusted by reducing this value in percentage terms. To make adjustments consult the 'User configuration menu', '1. MAXIMUM RPM'.

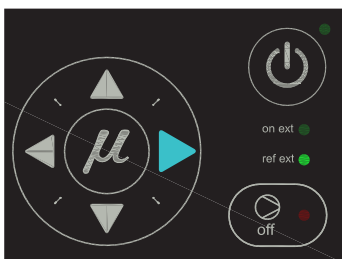
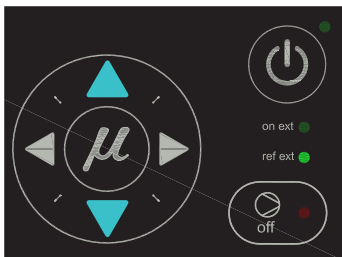
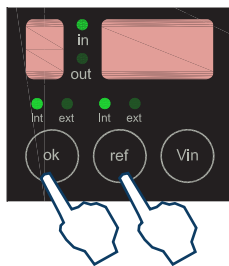

Mode of operation with internal pumping control and external speed control

In this operating mode, pumping is controlled from the equipment and speed is controlled by a 0-10 V external signal from the main machine.

Follow the steps below to use this operating mode:

1. Press the ON/OFF button to light up the control card.
2. Select 'ok' in the position 'int' and 'ref' in the position 'ext'. The 'ref ext' LED will illuminate when voltage is received.

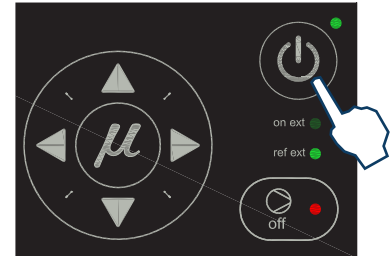

To activate the start-up status, all of the following conditions must be met:

- That the signal from the main machine reaches input E2 and its value is not 0.
- That the input for pumping permission (E4) at central control is activated, as pumping is not possible unless the equipment temperature is OK.
- That pumping is enabled with the pumping ON-OFF button (red LED is turned off).
- That the failure input is not activated (E5), in which case starting the pump would be impossible. In case of the pump be operating and this input is activated, pumping will cease immediately.

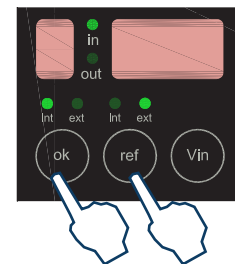

The system will wait for the speed signal from the main machine. When the signal has been received, if a speed has been previously set it will appear on the display and the pump will begin to rotate at the indicated speed.

If not, the rotation speed must be adjusted to the value required for the application. There are three ways to do this:

1. Change the voltage applied from the main machine.
2. Change the full scale (see section '1. MAXIMUM RPM' in the 'User configuration menu').
3. Modify the speed ramp (see section 'Configuring speed ramp').

Keeping the 'Vin' key pressed will show the voltage sent by the main machine.

The pump will stop whenever:

- The control card is disabled with its ON/OFF button.
- The pumping ON-OFF button is pressed (red LED is illuminated).
- When the MAXIMUM RPM ALARM TIME appears.
- When the MINIMUM RPM ALARM TIME appears.
- When the voltage signal from the main machine is zero.

The maximum full scale for admissible revolutions is 100 (we recommend working at speeds of not less than 10 rpm and not greater than 80 rpm).

The full scale can be adjusted by reducing this value in percentage terms. To make adjustments consult the 'User configuration menu', '1. MAXIMUM RPM'.

Mode of operation with external pumping control and internal speed control

In this operating mode, pumping is controlled from the main machine while speed is controlled from the equipment.

Follow the steps below to use this operating mode:

1. Press the ON/OFF button to light up the control card.
2. Select 'ok' in the position 'ext' and 'ref' in the position 'int'. The 'on ext' LED will be illuminated when temperature is ok.

To activate the start-up status, all of the following conditions must be met:

- That the input for pumping permission (E4) at central control is activated, as pumping is not possible unless the equipment temperature is OK.
- That pumping is enabled with the pumping ON-OFF button (red LED is turned off).
- If the external 'ok' mode (start-stop) is selected, the external 'ok' input (E3) must be activated.
- That the failure input is not activated (E5), in which case starting the pump would be impossible. In case of the pump be operating and this input is activated, pumping will cease immediately.

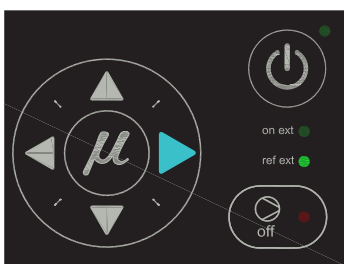
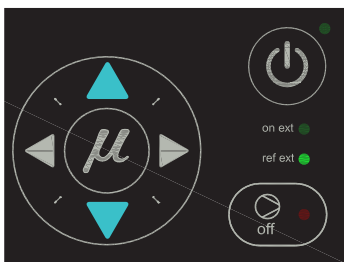
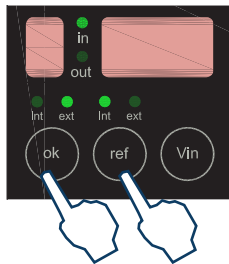
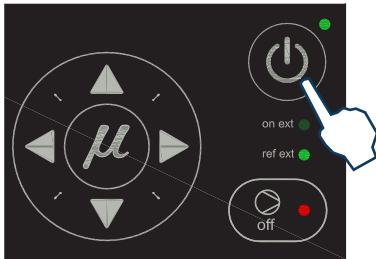

The system will wait for the pumping control signal from the main machine. If a speed has been previously set, this value will be shown on the display and the pump will start to rotate at the speed indicated provided that all prior conditions are met. Otherwise:

3. Using the up/down arrows, select the rotation speed and/or wait for pumping permission to be enabled (red LED is turned off).

At this moment, the pump will start to rotate at the speed indicated on the display.

4. Adjust the rotation speed to the value required for the application. The selected value is set pressing the right arrow key after blinking three times.

The pump will stop whenever:

- The control card is disabled with its ON/OFF button.
- The pumping ON-OFF button is pressed (red LED is illuminated).
- When the pumping permission input is deactivated (E3).
- When a variator error signal is activated (E5).
- When the MAXIMUM RPM ALARM TIME appears.
- When the MINIMUM RPM ALARM TIME appears.

The maximum full scale for admissible revolutions is 100 (we recommend working at speeds of not less than 10 rpm and not greater than 80 rpm).

The full scale can be adjusted by reducing this value in percentage terms. To make adjustments consult the 'User configuration menu', '1. MAXIMUM RPM'.

Mode of operation with external pumping control and external speed control

In this working mode, both pumping and speed are controlled from the main machine.

Follow the steps below to use this operating mode:

1. Press the ON/OFF button to light up the control card.
2. Select 'ok' in the position 'ext' and 'ref' in the position 'ext'. The 'on ext' and 'ref ext' LEDs will be illuminated when temperature is ok and voltage is received.

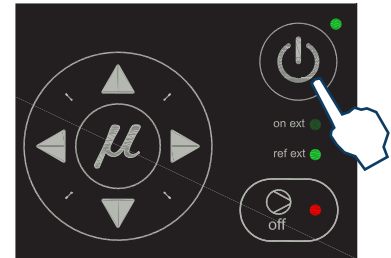

To activate the start-up status, all of the following conditions must be met:

- That the signal from the main machine reaches input E2 and its value is not 0.
- That the input for pumping permission (E4) at central control is activated, as pumping is not possible unless the equipment temperature is OK.
- That pumping is enabled with the pumping ON-OFF button (red LED is turned off).
- If the external 'ok' mode (start-stop) is selected, the external 'ok' input (E3) must be activated.
- That the field MAXIMUM RPM is not set to zero (this field is available on the control card 'User configuration menu').
- That the failure input is not activated (E5), in which case starting the pump would be impossible. In case of the pump be operating and this input is activated, pumping will cease immediately.

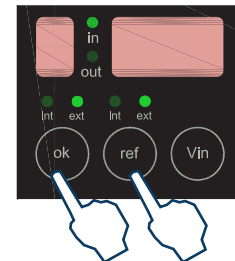

The system will wait for the main machine to send the pumping activation and rotation speed signals. When this signal has been received, if a speed has been previously set, this value will appear on the display and the pump will start to rotate at the indicated speed.

If not, the rotation speed must be adjusted to the value required for the application. There are three ways to do this:

1. Change the voltage applied from the main machine.
2. Change the full scale (see section '1. MAXIMUM RPM' in the 'User configuration menu').
3. Modify the speed ramp (see section 'Configuring speed ramp').

Keeping the 'Vin' key pressed will show the voltage sent by the main machine.

The pump will stop whenever:

- The control card is disabled with its ON/OFF button.
- The pumping ON-OFF button is pressed (red LED is illuminated).
- When the pumping permission input is deactivated (E3).
- When a variator error signal is activated (E5).
- When the MAXIMUM RPM ALARM TIME appears.

- When the MINIMUM RPM ALARM TIME appears.
- When the voltage signal from the main machine is zero.

The maximum full scale for admissible revolutions is 100 (we recommend working at speeds of not less than 10 rpm and not greater than 80 rpm).

The full scale can be adjusted by reducing this value in percentage terms. To make adjustments consult the 'User configuration menu', '1. MAXIMUM RPM'.

The pump control card is designed with certain parameters programmed at Meler that can be modified if necessary to meet your requirements. Modifications may be made through the user configuration and programming speed ramp menus.

User configuration menu

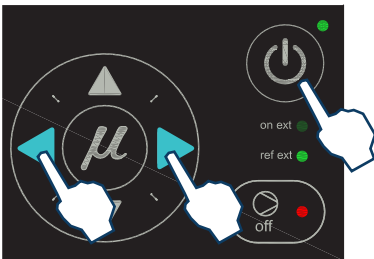

To open this menu, press simultaneously the left arrow key, the right arrow key, and ON/OFF button of the pump control card.

If the security password is enabled, the security password must be entered to access this menu. By default, all the equipments is set to 000 that the user may change at any time. If the security password is not enabled, direct access will be given to the following menu:

- 1. MAXIMUM RPM ALARM:** this will be a value set between 0 and the value programmed in the MAXIMUM RPM field. If we do not wish this alarm to be operational it must be programmed to the MAXIMUM RPM value. The default value is 100 (consequently, alarm not operational).
- 2. MAXIMUM RPM ALARM TIME:** this will be a period programmed between 0 and 999 (in seconds). In the event that the output RPM exceed the value programmed for MAXIMUM RPM ALARM during the period established in this field, MAXIMUM RPM error will be activated (the pump will stop, and an error message will be displayed). By default, this value is 30 seconds.
- 3. MINIMUM RPM ALARM:** this will be a value set between 0 and the value programmed in the MAXIMUM RPM field. This value may never be greater than the value programmed in the MAXIMUM RPM ALARM field. If the value programmed is '0' the error function will be disabled. By default, this value is 0 (disabled).
- 4. MINIMUM RPM ALARM TIME:** this will be a period programmed between 0 and 999 (in seconds). In the event that the output RPM are less than the programmed value for MINIMUM RPM ALARM during the period established in this field, MINIMUM RPM error will be activated (the pump will stop, and an error message will be displayed). By default, this value is 30 seconds,
- 5. PUMPING SAFETY FUNCTION:** this consists of an editable field (0 enabled – 1 disabled). By default, this is set to '0' (enabled).
- 6. SECURITY PASSWORD:** The security password may be changed in an editable field. The current password must be entered to access and edit the field. (See the section 'Password security' in this chapter).
- 7. ENABLING THE SECURITY PASSWORD:** this consists of an editable field (0 disabled, 1 enabled). The current password must be entered to access and edit the field. By default, this is set to '0'. (See the section 'Password security' in this chapter).

Displaying alarms and reset function

Maximum rpm alarm

This alarm will be triggered when the motor rotates at a speed exceeding the MAXIMUM RPM ALARM value for the period established in the MAXIMUM RPM ALARM TIME field.

- When this alarm is triggered, an 'E.H.' error is shown on the control card.
- To reset this error, you must turn off and start up the control card with its ON/OFF button.

Minimum rpm alarm

This alarm will be triggered when the motor rotates at a speed that is below the MINIMUM RPM ALARM for the period established in the MINIMUM RPM ALARM TIME field.

- When this alarm is triggered, an 'E.L.' error is shown on the control card.
- To reset this error, you must turn off and start up the control card with its ON/OFF button.

Variator alarm

This alarm is triggered when the control card input is activated by a variator error signal.

- When this alarm is triggered, an 'E.U.' error is shown on the control card.
- The error message will be maintained while the variator error input (E5) remains active. As soon as this input is deactivated the alarm will be reset.

Note: In the event that a RPM alarm and a variator ERROR alarm should coincide, alternating messages will appear on the display.



Configuring speed ramp

For equipment operating in external reference, the display will show the current pump rotation set point (input reference conversion as per the full scale and the conversion table).

The conversion table may be programmed with up to 5 points (input voltage (V) and output speed (RPM)).

By default the table is programmed (0 V = 0 rpm and 10 V = 100 rpm):

Notes on the editable values in the conversion table:

	Vin	RPMs Out
punto 1	0,0	0
punto 2	10,0	100
punto 3	10,0	100
punto 4	10,0	100
punto 5	10,0	100

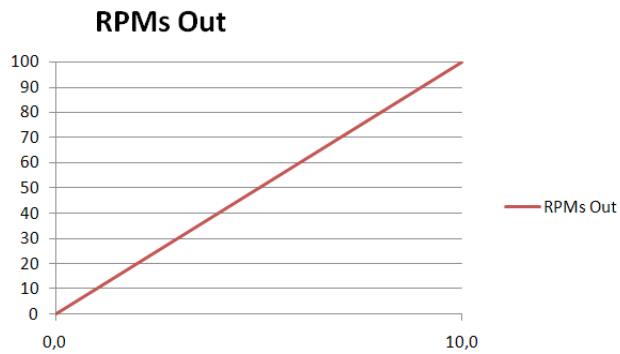

- The value for voltage must always be shown to one decimal place.
- Point 1 is the starting point for the speed ramp, and therefore the voltage will always be 0, while the value for output RPM is editable.
- The possible values for each point must be equal to or greater than the value corresponding to the previous point.
- Point 5 is the final point for the speed ramp, and therefore the voltage will always be 10, while the value for output RPM is editable.
- It is not necessary to program the value for MAXIMUM RPM in this table.
- If, at any point, the maximum value for Vin = 10 V is entered, the corresponding values for Vin and RPM at higher points will be automatically updated according to the value for this point.
- If, at any point, the maximum value is entered, that is, RPM = MAXIMUM RPM, the corresponding values for RPM at higher points will be automatically updated to MAXIMUM RPM.

	Vin	RPMs Out
punto 1	0.0	0
punto 2	2.5	25
punto 3	10.0	80
punto 4	10.0	80
punto 5	10.0	80

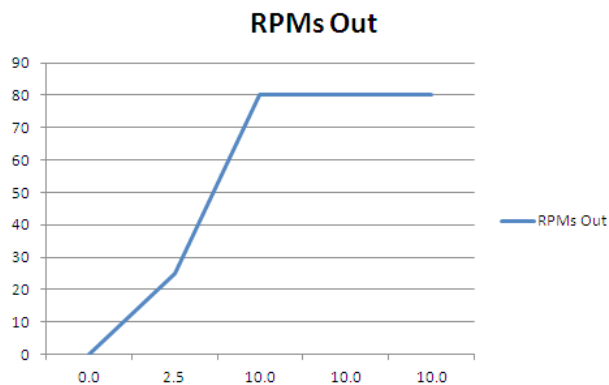

Programming speed ramp

To access this menu and program the different points corresponding to the voltage-speed ratio, you must select external reference ('ref ext' LED is illuminated) and press the right arrow key. Then the following message is displayed:

The IN LED to the position **ON** and the OUT LED to the position **OFF, 1 000**, **NOT EDITABLE**; press the right arrow to go to the next point:

The IN LED to the position **OFF** and the OUT LED to the position **ON, 1 XXX**, which means that the output speed is being programmed for point 1 (when the input voltage is 0 V); with the up/down arrow keys the value may be modified, within a range from 000 to MAXIMUM RPM; press the right arrow key to go to the next point:

The IN LED to the position **ON** and the OUT LED to the position **OFF, 2 XXX**, which means that the input voltage value is being programmed for point 2; with the up/down arrow keys the value may be modified, within a range from 00.0 to 10.0 (to one decimal place); press the right arrow key to go to the next point:

The IN LED to the position **OFF** and the OUT LED to the position **ON, 2 XXX**, which means that the output speed value is being programmed for point 2; with the up/down arrow keys the value may be modified, within a range from 000 to MAXIMUM RPM; press the right arrow key to go to the next point:

The IN LED to the position **ON** and the OUT LED to the position **OFF, 3 XXX**, which means that the input voltage value is being programmed for point 3; with the up/down arrow keys the value may be modified, within a range from 00.0 to 10.0 (to one decimal place); press the right arrow key to go to the next point:

The IN LED to the position **OFF** and the OUT LED to the position **ON, 3 XXX**, which means that the output speed value is being programmed for point 3; with the up/down arrow keys the value may be modified, within a range from 000 to MAXIMUM RPM; press the right arrow key to go to the next point:

The IN LED to the position **ON** and the OUT LED to the position **OFF, 4 XXX**, which means that the input voltage value is being programmed for point 4; with the up/down arrow keys the value may be modified, within a range from 00.0 to 10.0 (to one decimal place); press the right arrow key to go to the next point:

The IN LED to the position **OFF** and the OUT LED to the position **ON, 4 XXX**, which means that the output speed value is being programmed for point 4; with the up/down arrow keys the value may be modified, within a range from 000 to MAXIMUM RPM; press the right arrow key to go to the next point:

The IN LED to the position **ON** and the OUT LED to the position **OFF, 5 100**, **NOT EDITABLE**; press the right arrow key to go to the following message:

The IN LED to the position **OFF** and the OUT LED to the position **ON, 5 XXX**, which means that the speed value is being programmed for point 5; with the up/down arrow keys the value may be modified, within a range from 000 to MAXIMUM RPM; press the right arrow key to exit the menu.

Press the right arrow key to return to the menu, and the initial message is displayed: The IN LED to the position **ON** and the OUT LED to the position **ON, 1 000**.

To exit this menu, the equipment must be turned off and started up using the control card ON/OFF button.

To save the newly entered data, use the right and left arrow keys to go forward or backward in the menu: if any field has been modified using the up/down arrow keys, and the ON/ OFF button is pressed to turn the equipment off, the data will not be saved.

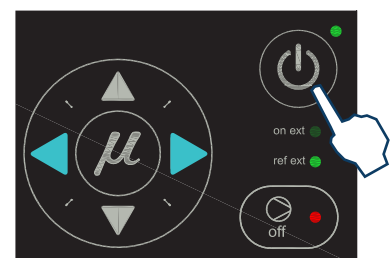
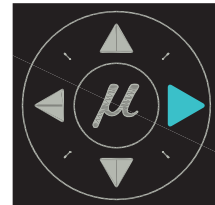
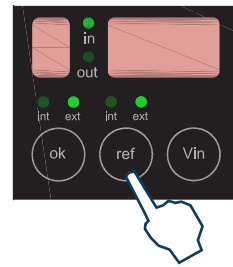
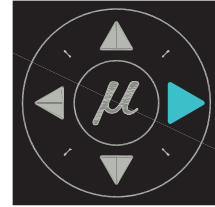

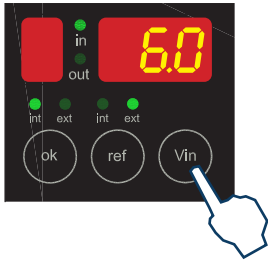

Current Vin voltage display

Whenever the Vin key is held pressed, the three digits on the right will show the input voltage reading to one decimal point.

If the values for any point in the speed ramp table is being edited, and the Vin key is held pressed for 3 seconds, the voltage value which is operating at this time it will be copied to that value on the table.

Regulating the bypass valve

The pump system with gear pump supplies a constant flow of adhesive based on the pump rotation speed.

In this type of system, the pressure generated by the pump is a result of the retentions produced in the circuit (length and diameter of the hose, elbows in the couplings, diameter of nozzle outputs, etc.) and the adhesive itself (viscosity).

For safety reasons, this pressure must be discharged when the circuit exceeds the working value -normally with the circuit closed and the pump activated- which requires the use of a discharge or bypass valve.

This valve may be a manual adjustment valve, using a threaded allen head screw, or with pneumatic control, using a pressure regulator and a pressure gauge. In the latter case, the adhesive circuit pressure has a 1:13 ratio to the pressure displayed on the pressure gauge.

Adjusting the manual valve

Follow the steps below to set the pressure using this type of valve (approximate):

1. Screw the spindle in as far as possible in the clockwise direction. In this position, the maximum pressure is 50.98 kg/cm² (50 bar).
2. Gradually loosen anti-clockwise until the desired pressure is reached. Each millimetre the spindle sticks out corresponds -approximately- to a reduction of 9 kg/cm² (8.82 bar).

By default, the equipment is calibrated with a hydraulic pressure of approximately 40 bar.



Turning off the melter equipment

If you need to disconnect the melter equipment:

1. Turn OFF the pumping switch on the front of the electrical cabinet.
2. Turn OFF the machine switch on the door of the electrical cabinet.
3. Disconnect the pneumatic power to the applicators and the electrical power to the control unit programmer, if there is one.



5. MAINTENANCE

Warning: The melter equipment is equipped with current technology, but has certain foreseeable risks. Therefore, only allow qualified personnel with enough training and experience to operate install or repair this equipment.



The following table briefly summarizes the indications for adequate melter/ equipment maintenance. Always read the corresponding section carefully.

Operation	Frequency	Refer to
External cleaning	Daily	Equipment cleaning
System depressurization	Before performing maintenance tasks and repairing the hydraulic system	System depressurisation
Remove electrical cabinet	Before performing maintenance of distributor, pump or gear motor	Access inside the unit
Filter cleaning or changing	- As needed (once a year minimum) - With each adhesive change	Filter maintenance
Emptying and cleaning the tank	- When burnt adhesive is present - With each adhesive change	Cleaning the tank
Check for pump leaks	Depending on the hours of operation and the temperature and speed parameters (min. once per month)	Pump maintenance
Check the lubrication (motor and gear)	Depending on the temperature and conditions of use (max. 8000 hours)	Gear motor maintenance
Check thermostat operating	- Checking while working	Safety thermostat

If the equipment does not work or works incorrectly, you can requested help from our Technical Service.

Equipment cleaning

To continue to take advantage of the melter's benefits and to ensure the perfect mobility of its components, it is necessary to keep all its parts clean.

Warning: Risk of electric shock. Carelessness may result in injury or death.



Clean the exterior using a cloth moistened with water. Do not use flammable liquids or solvents.

To carry out external cleaning:

- Use cleaning products compatible with polyamide materials.
- Apply the cleaning product with a soft cloth.
- Do not use sharp tools or scrapers with sharp edges.

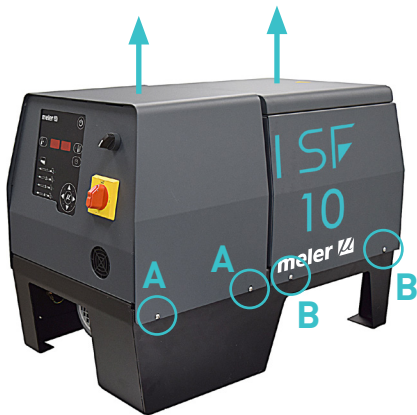

Removing exterior panels

1. Turn off the melter.
2. To remove the electrical cabinet cover, remove the four screw as indicated (A), and slide it upwards.
3. To remove the tank cover, remove the four screw as indicated (B), and slide it upwards. The lid and the casing are removed from the tank at the same time.

System depressurisation

Even with the motor turned off, residual pressure may exist in the circuit. This must be kept in mind when performing any operation on the hydraulic circuit.

Before disconnecting any hydraulic element or opening any distributor outlet, it is necessary to perform the following steps:

1. Turn off the machine switch on the door of the electrical cabinet.
2. Slightly loosen the filter plug housed in the distributor to free any residual pressure from the circuit. Adhesive residue falls down the side of the plug.
3. Purge all applicators that have been used either manually or with the corresponding program command.

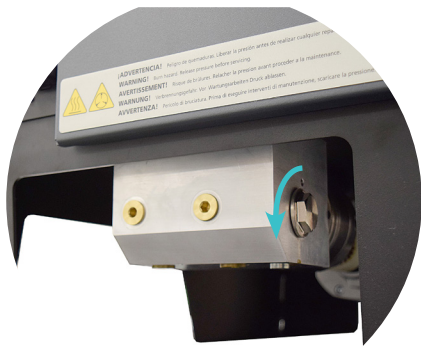

Warning: Use appropriate protective equipment for high temperatures.

Access to distributor and pump gear- motor

The parts are easily accessible from the bottom of the chassis and there is no need to disassemble any element.

Warning. Do not tilt the equipment to access these items without making sure that the tank is empty.



Access to the electrical connections box of the gear-motor

1. Turn off the melter.
2. Remove the rear cover to access the electrical connections gear-motor box.



Warning: Risk of electric shock. Carelessness may result in injury or death.

Gear-motor disassembly

1. Turn off the melter.
2. Remove the tank cover. See 'Removing exterior panels' point.
3. Loosen the four retaining screws to allow the gear-motor to move out of position and release the coupling to the pump.
4. To remove the gear-motor, loosen the four screws.

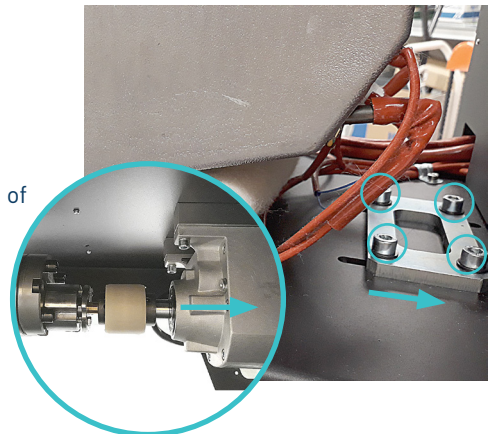

Warning: Risk of electric shock. Carelessness may result in injury or death.

Filter maintenance

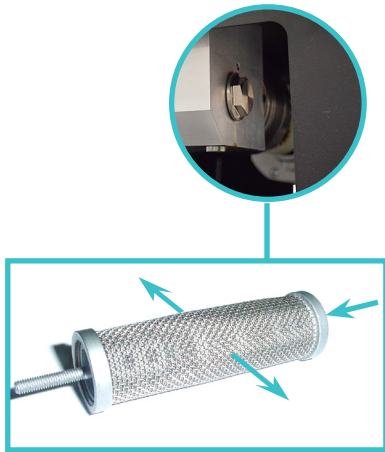

The melters are equipped with a 100 mesh pump filter. The filter prevents impurities and burnt adhesive remains from being pushed out from the tank by the pump.

When the filter is removed from its housing, all the impurities remain inside so that the inside of the distributor stays perfectly clean. The filter can be cleaned or replaced with a new one.

No rule exists for determining when the filter should be changed. Several factors influence this decision:

- The type and purity of the adhesives used.
- The working temperatures of the adhesive.
- Adhesive consumption in relation to the time in the tank.
- Changes to the type of adhesive used.

In any case, we recommend that the filter is checked and cleaned at least every 1000 hours of operation (melter turned on).



Warning: Always wear protective gloves and safety glasses. Risk of burns.

To change the filter:



1. Depressurise the system.
2. Using a 22 mm wrench, unscrew the hexagonal filter cap turning left and remove it.
3. Unscrew the filter nut (1) and remove the mesh (2) from the filter body (3).
4. Depending on how dirty the mesh (2) is, clean or replace it, following any waste regulations in force.
5. Screw the nut (1) back in place and place the filter inside the distributor.
6. Replace the filter cap screw if damaged.
7. Screw the filter cap turning right and tighten as far as possible.
8. Continue to work as normal.



Warning: Use the appropriate protective equipment for high temperatures.

Cleaning the tank

The hot-melt tank must be cleaned on occasion to maintain its fusion and anti-adherence properties. The tank is covered on the inside with PTFE and inclined enough to aid unloading the hot-melt and to avoid it from being retained inside when consequential burning occurs.

Furthermore, when adhesives are mixed, reactions may occur between them, causing a degeneration and thus problems in unloading in the direction of the pump.

Therefore, it is recommended to clean the deposit every time that:

- A change is made to a different type of hot-melt.
- Too much burnt material is generated in its interior.

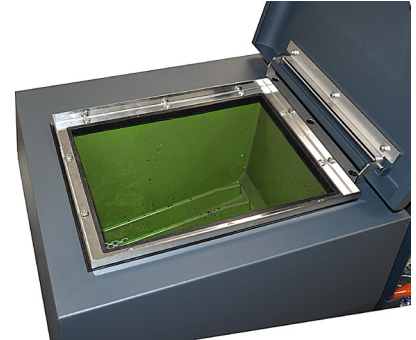

Changing adhesive type

1. Use up as much of the adhesive as possible.

If it is necessary to unload the adhesive without having used it up as much as possible, follow the instructions in the section 'Emptying the tank'.

2. Clean the remains of hot-melt adhesive on the inside of the tank.

Warning: Use appropriate protective equipment for high temperatures.

3. Add the appropriate type and quantity of the new adhesive, wait for it to melt and pump at least one full tank through the system (hoses and applicators).



Cleaning burnt adhesive

1. Empty the tank directly (see the section 'Emptying the tank') to prevent the burnt material from passing through the pump circuit.
2. Clean the adhesive remains and burnt material inside the tank. Do not use sharp objects that might damage the inside coating.

Warning: Use appropriate protective equipment for high temperatures.

3. Add the appropriate type and quantity of adhesive and wait for it to melt.
4. Remove the filter cartridge and clean it, if necessary (see the section 'Filter maintenance').
5. Reassemble the filter without the cartridge.
6. Pump a minimum of one tank through any distributor output.
7. Remove the filter and attach it to the corresponding cartridge. Reinstall it in the distributor.
8. Refill the tank with adhesive, wait for it to melt and continue working as usual.





Warning: Whenever you handle the filter or any other element subject to pressure, you must always perform a system depressurization first (see the corresponding section)

Emptying the tank

During normal maintenance activities, it is recommended, and sometimes necessary to empty the tank directly, without passing the adhesive through the pump system.

Empty the tank following these indications:

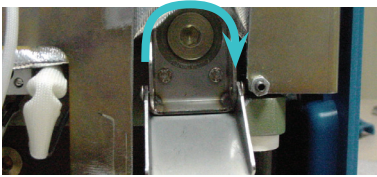

1. Keep the tank at working temperature.
2. Remove the tank cover and then its casing.
3. Lower the emptying chute attached to the tank and put a suitable container in position.
4. Unscrew the plug and allow the adhesive to flow freely into the container.
5. Once it is completely empty, clean the exit hole and chute of remains of adhesive.
6. Put the plug back in position.
7. Raise the emptying chute and put the cover of the casing back in position.



Warning: Use appropriate protective equipment for high temperatures.

Pump maintenance

Inspecting for leaks

The pump is equipped with a gasket system on the shaft to prevent adhesive from leaking through it. On occasion, some adhesive may leak out, which makes it necessary to retighten the screws or change the gasket.



Warning. Do not tilt the equipment to access these items without making sure that the tank is empty.



Warning: Changing the gasket with a hot pump.

In the event of a leak through the seat gaskets between the pump and the distributor, re-tighten the pump-distributor binding screws; if the leak continues, replace the gaskets. To do this:

1. Release the shaft coupling from the pump.

2. Retighten or remove the screws that hold the gasket in place.
3. Replace the gaskets and reassemble the parts.

Occasionally, as a result of the system’s heating-cooling cycles, it may be necessary to retighten the screws.

Before making any changes, establish the location of the leak. However, before replacing any parts and in case of any doubt, we recommend that you consult the Meler Technical Service Centre.

Warning: Always wear protective gloves and goggles. Risk of burns.

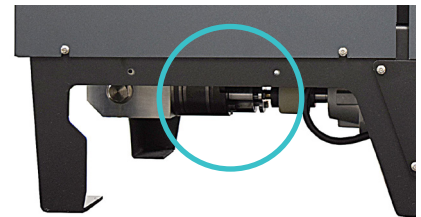

Gear motor maintenance

Cleaning the motor fan

Periodically inspect the condition of the motor fan and its vent screen.

If dust has accumulated, blow gently with air to clean it (remove the protective cover, if necessary).

Checking the lubricant

The gear reducers are delivered filled with synthetic grease for lubrication -free of outside contamination- ‘for life’. Ambient temperature 0 ÷ 40 °C, with peaks of as low as -20 °C and up to +50 °C.

Use only those lubricants recommended by the manufacturer. The use of other types may cause premature wear or damage to the gear reducer.

Approximately 0.1 kg of lubricating grease fits in the gear reducer model used.



Recommended lubricants

BRAND	TYPE OF OIL
IP	Telesia Compound A
SHELL	Tivela Compound A
MOBIL	Glygoyle Grease 00

Safety Thermostat

If there is a deactivation of the thermostat, dismantle the tank casing with the cover and slide the electrical cabinet along. When you can see the thermostat, press the button indicated to reset it.



This page is intentionally left blank.

6. TECHNICAL CHARACTERISTICS

Generals

SF 10

SF 20

Tank capacity		10 l / 2.64 gal	20 l / 5.28 gal
Pumping rate		Simple pump 8 cc/rev (*)	Simple pump 8 cc/rev (*)
Melting rate		9.0 kg/h (20 lb/h) (*)	9.0 kg/h (44 lb/h) (*)
Number of outputs		4 electrical / 4 hydraulic	4 electrical / 4 hydraulic
Temperature range		40 to 200°C (104 to 392°F)	40 to 200°C (104 to 392°F)
Temperature control		RTD ±0.5°C (±1°C) / ±0.9°F (±0,8 °F) Pt-100 or Ni-120	RTD ±0.5°C (±1°C) / ±0.9°F (±0,8 °F) Pt-100 or Ni-120
Max. working pressure (at 6 bar)		80 bar (1160 psi)	80 bar (1160 psi)
Max. installation power (at 230V)	230V 3L	3500W (per phase)	4000W (per phase)
	230V 2L	3000W	2500W
External requirements		Temperature ok output External stand-by activation Outputs disabled external control (optional) Low level output Motor start up input Motor speed control input Failures in pumping card output	Temperature ok output External stand-by activation Outputs disabled external control Low level output Motor start up input Motor speed control input Failures in pumping card output
Electrical requirements		2 ~ 230V 50/60Hz + PE 3 ~ 230V 50/60Hz + PE	2 ~ 230V 50/60Hz + PE 3 ~ 230V 50/60Hz + PE
Workplace temperature		0 to 40°C / 32 to 104 °F	0 to 40°C / 32 to 104 °F
Dimensions		770 x 385 x 510 mm 33.1 x 15.6 x 20.1 in 770 x 385 x 885 mm (lid open) 33.1 x 15.6 x 37 in (lid open)	770 x 385 x 605 mm 33.1 x 15.6 x 23.8 in 730 x 360 x 985 mm (lid open) 33.1 x 15.6 x 40.4 in (lid open)
Weight (aprox)		22 kg / 48,5 lb (empty)	36 kg / 79.3 (empty)

(*) Under standard conditions

Dimensions

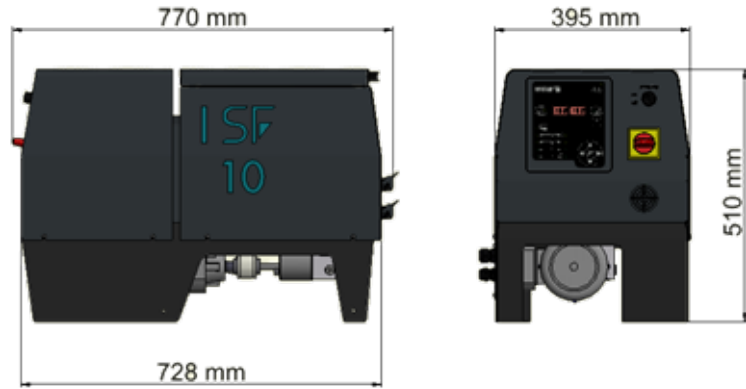

Electrical connection



Hoses connection

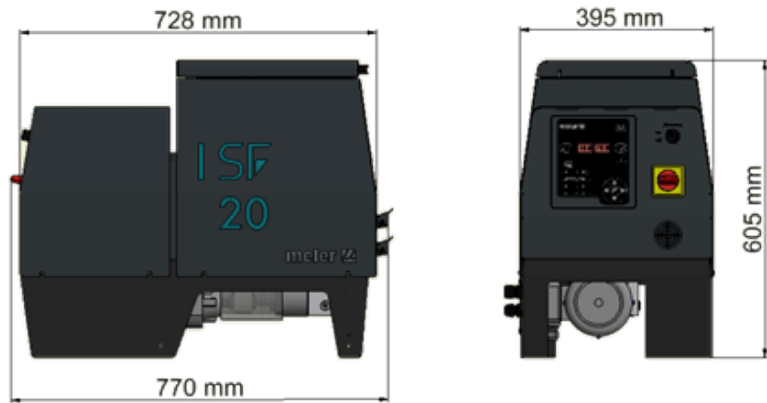

Electrical connection



Hoses connection

7. ELECTRICAL DRAWINGS

To view the the electrical drawing of the purchased equipment, see the USB of electrical drawings included.

This page is intentionally left blank.

8. SPARE PARTS LIST

The list of the most common spare parts for SF10 & SF20 series machines appears in this section, providing a quick and reliable guide to choosing them.

The spare parts are grouped together naturally, in the same way as they are located in the melters.

As a visual aid, drawings of the parts are included and are numbered to help identify them in the list.

The lists provide the reference and name of the spare part, indicating, when necessary, whether the reference corresponds to the 10 or 20 litre model.



A. TANK ASSEMBLY

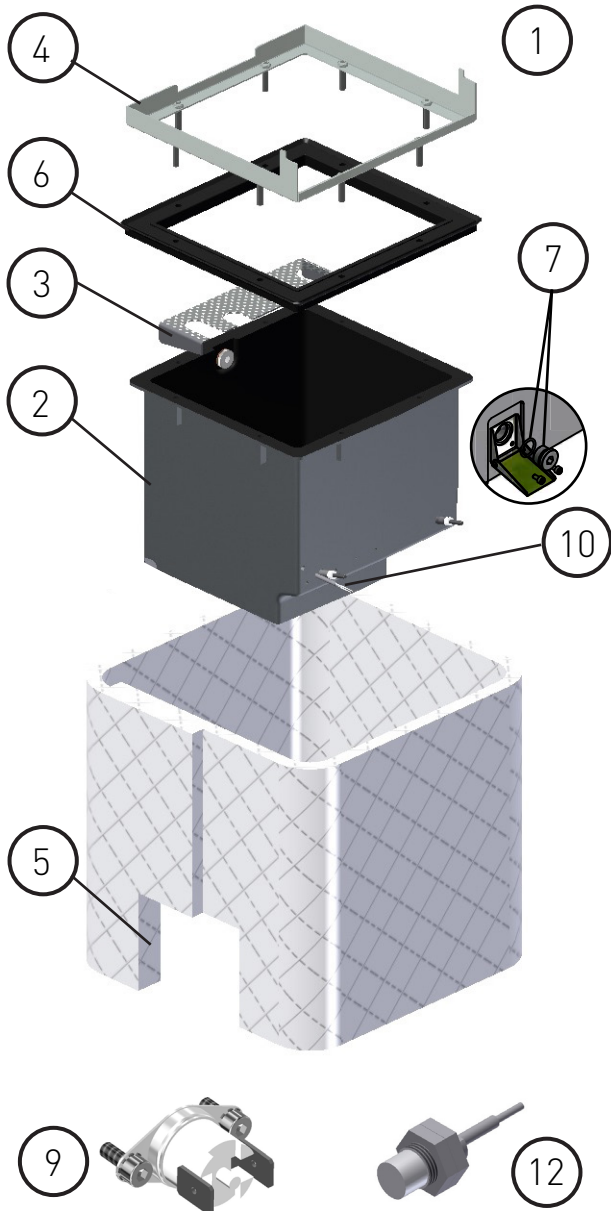

N°	Ref.	Description
1	150125930	Complete tank assembly SF10 230V
1	150125940	Complete tank assembly SF20 230V
2	150125950	PTFE coated tank SF10 230V
2	150125960	PTFE coated tank SF20 230V
3	150113370	Tank grid micron 5-10L
3	150114880	Tank grid micron 20L
4	150125970	Inlet tank SF10
4	150125980	Inlet tank SF20
5	150125990	Tank insulation mantle SF10
5	150126000	Tank insulation mantle SF20
6	150113450	Insulation mantle inlet tank micron 10
6	150113460	Insulation mantle inlet tank micron 20
7	150113270	Drain plug with o-ring
8	10030007	Current connection strip
9	150114500	Safety thermostat, up to 200°C
10	150114530	Sensor Pt100
10	150117570	Sensor Ni120
12 (*)	150110140	Capacitive detector Rechner KXS-M12/25

(*) optional

B. DISTRIBUTOR

N°	Ref.	Description
1	150126010	Mechanical pressure regulator
2	150026280	Mechanical pressure regulator o-ring
3	150126020	Mechanical pressure regulator spring
4	150026060	Closure needle of pneumatic pressure regulator
5	150029000	Filter plug with o-ring
6	10100053	Filter plug o-ring
7	10100090	Pump filter unit
8	10100051	Pump filter 100 mesh
9	10120095	Compensation valve plug with o-ring
10	10120096	Compensation valve plug
11	10100082	Pump plug with o-ring
12	10100083	Pump o-ring

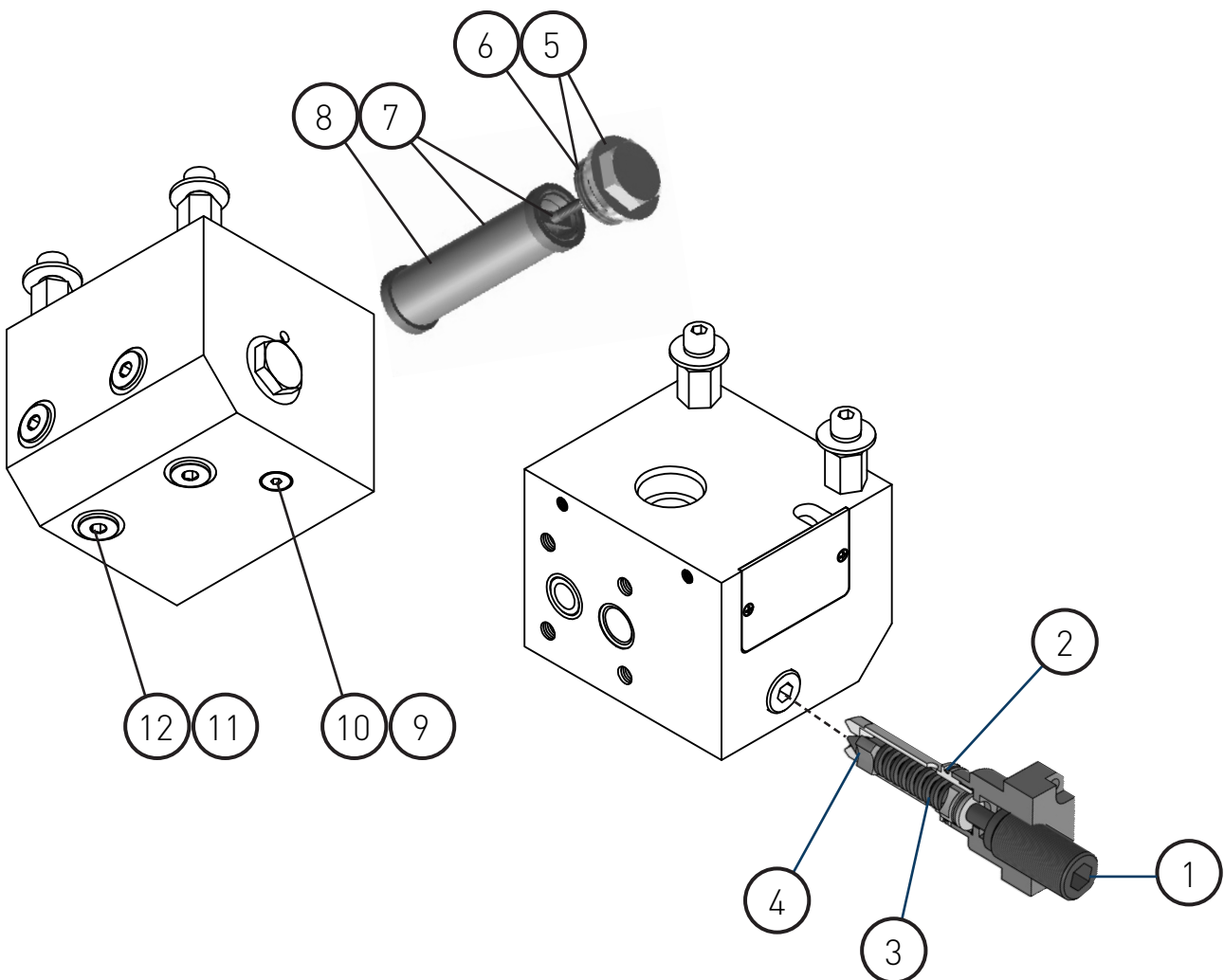

D. GEARED MOTOR-PUMP ASSEMBLY

N°	Ref.	Description
1	150126030	Geared motor
2	150117150	Simple pump motor coumpling
3	150025970	Simple gear pump 8 cc/rev
4	150026430	Simple pump o-rings

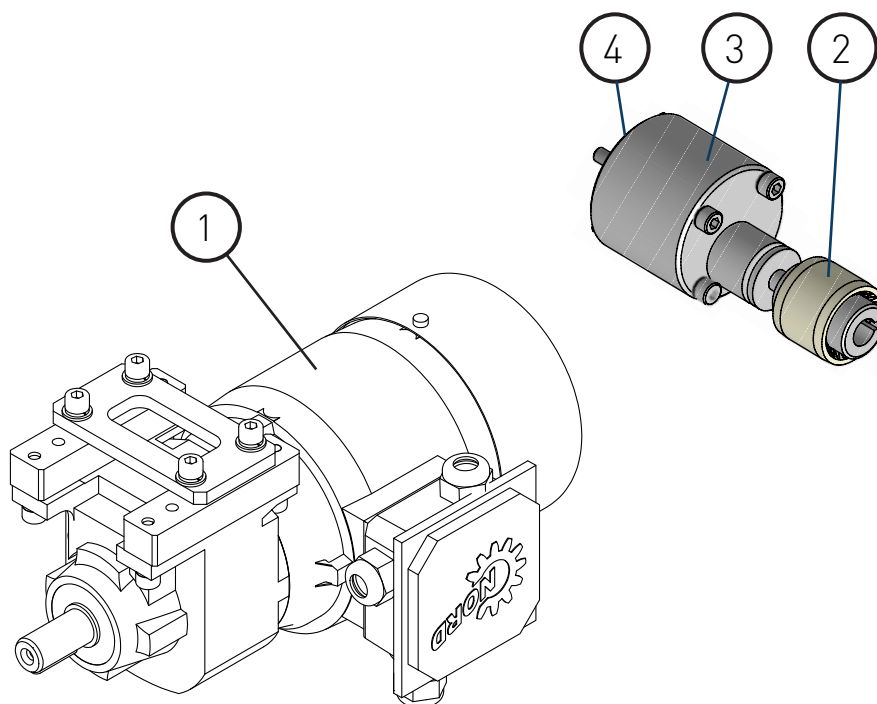

E. ELECTRIC ASSEMBLY

N°	Ref.	Description
1	10010300	Fuse 6,3A 5x20
2	150028860	Fuse 6,3A 6x32
3	150021540	Fuse 16A 10x38
4	150114450	Control to power board ribbon cable assembly
5	150024740	Control to sensor board cable assembly
6	16010003	Female connector 8 pin (base housing)
7	150020720	Female connector 12 pin (base housing)
8	150119180	Cable gland Pg13.5
9	150119190	Cable gland Pg16
10	150126040	Amphenol connector
11	150114460	Power board to DC power supply cable micron 5-10-20
11	150114980	Power board to DC power supply cable micron 35

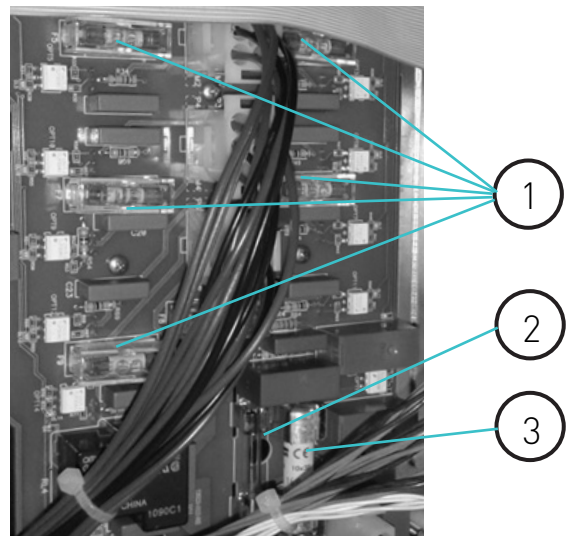
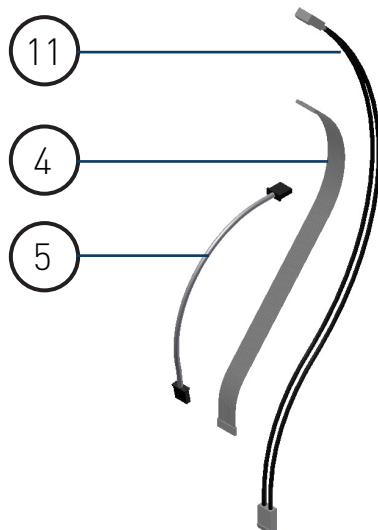
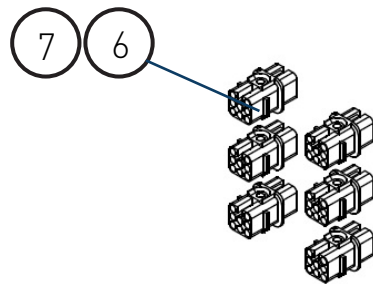
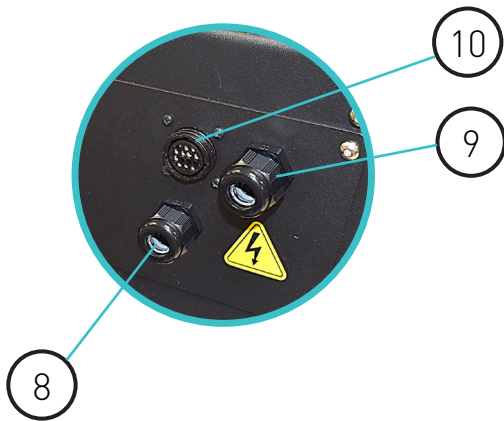

E. ELECTRIC ASSEMBLY

N°	Ref.	Description
1	150113660	Control board Micron
2	150113680	Power board Micron 6 outlets
3	150024710	Sensor board Micron Pt100/Ni120
4	150110970	Fuse 0,315A 5x20
5	150117100	Pump control board
6	150126050	Inverter Delta 0,4KW
7	150117120	Power supply 24V 2,2A
8	150114760	Capacitive detector and amplifier kit
9	150094760	3 contact Relay
10	150130490	Selector switch 2-position + NO contact
11	115002860	Disconnecter 40A 3 pole W/O Neutral
12	150126060	Disconnecter handle Red/Yw

